

Connect the dots and see who is filling up the bath.

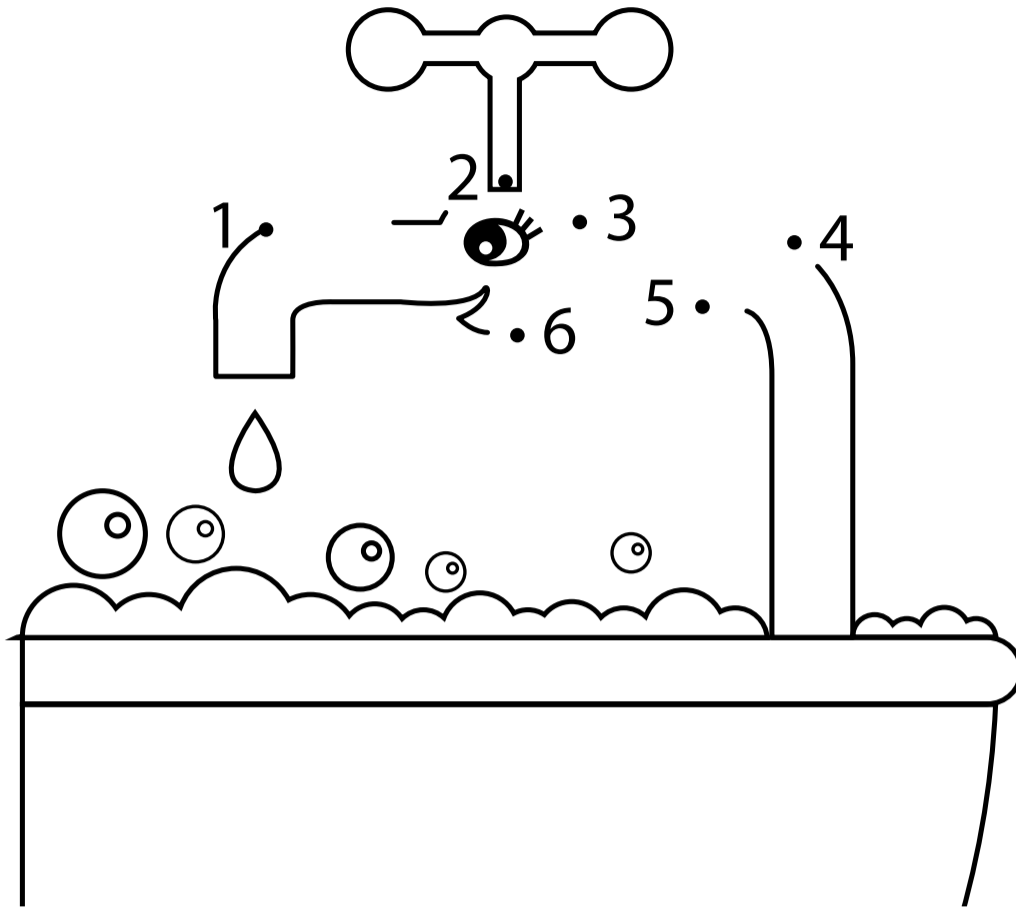

Don't waste electricity by filling the bath to the brim or topping up a cold bath with more hot water.

Ruby and the Powerpals is an e-book available free of charge from www.eskom.co.za/idm

Spot the five differences inside Freddy the fridge.

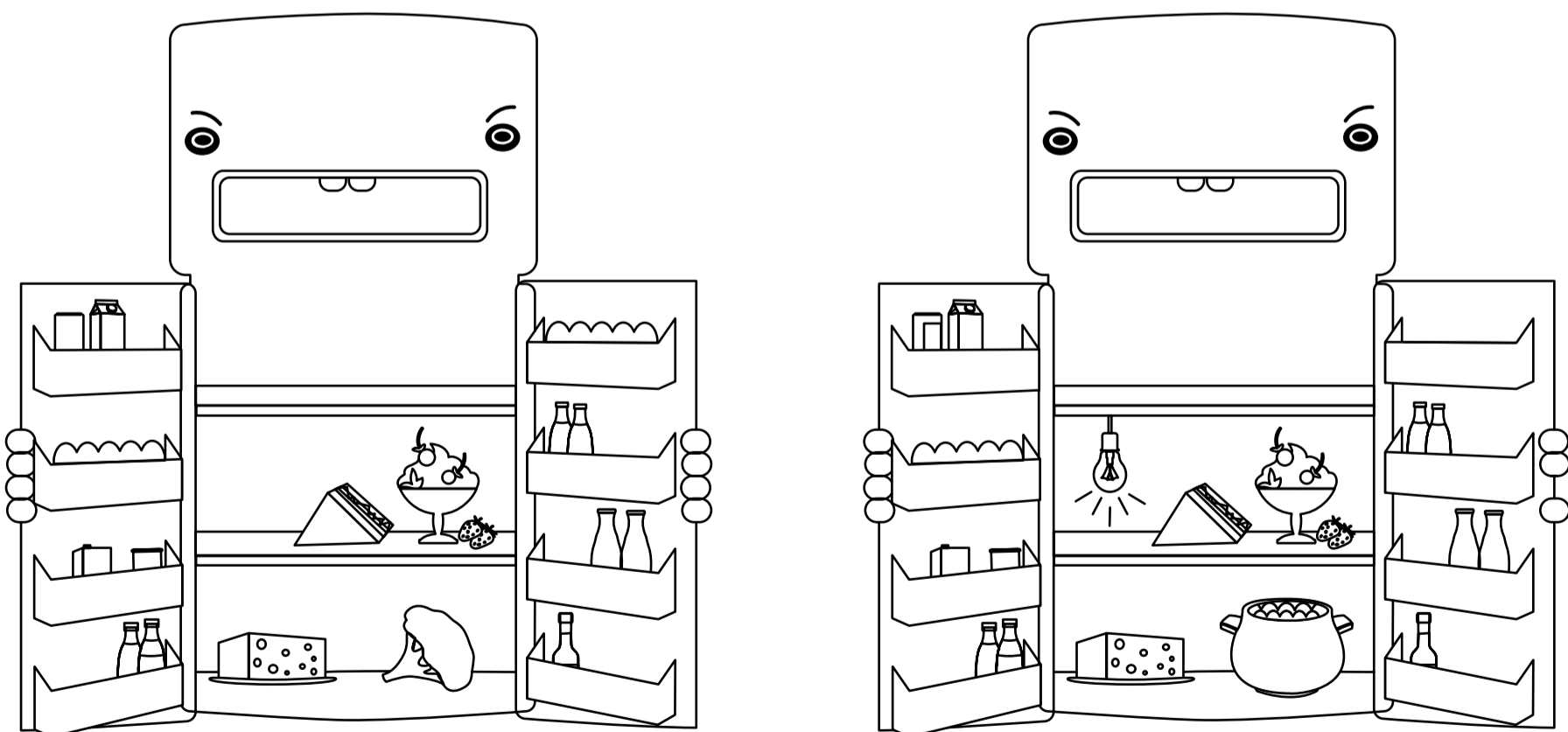

Before you open the fridge think about what you want inside and then close the door quickly in order to save electricity.

Ruby and the Powerpals is an e-book available free of charge from www.eskom.co.za/idm

Colour-in Ruby and her Powerpals.

The golden rule is, if you are not using it, switch it off.

Ruby and the Powerpals is an e-book available free of charge from www.eskom.co.za/idm

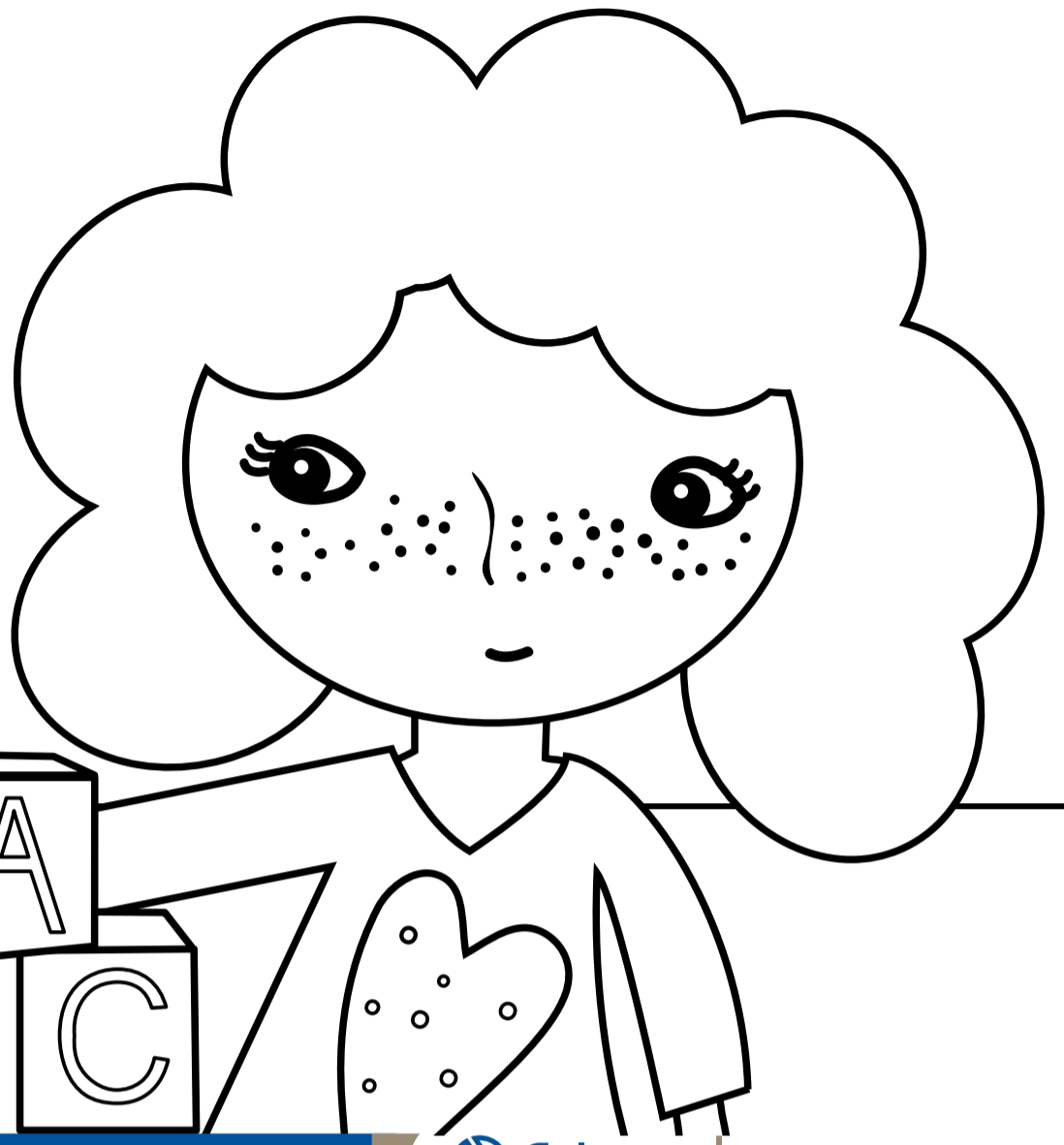
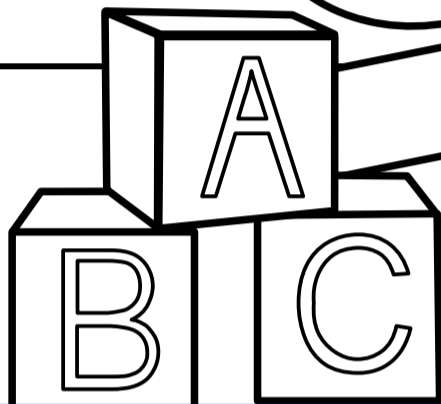
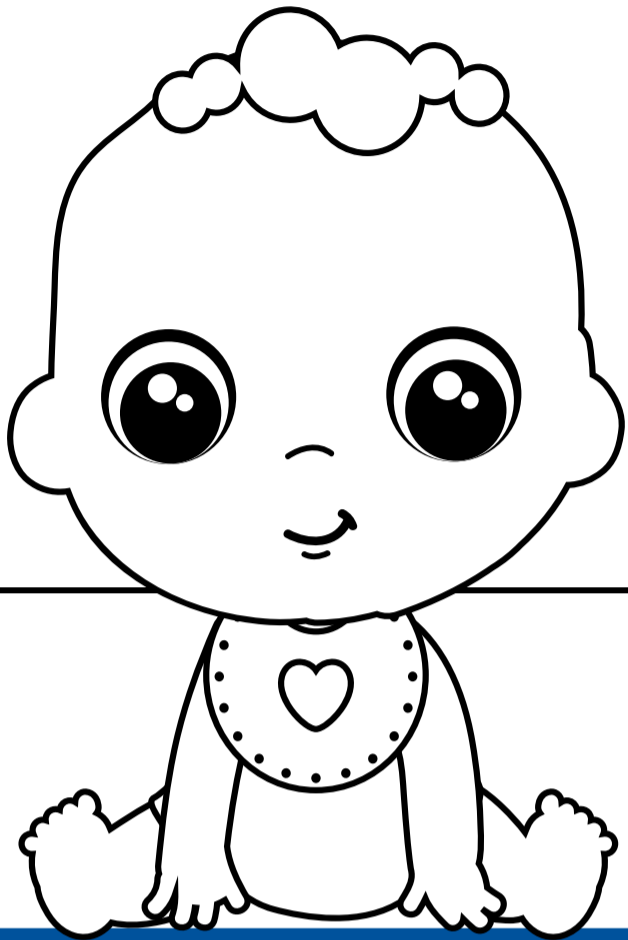

Powering your world

www.eskom.co.za/idm

Help Ruby get to the light switch.

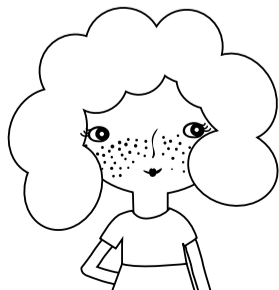
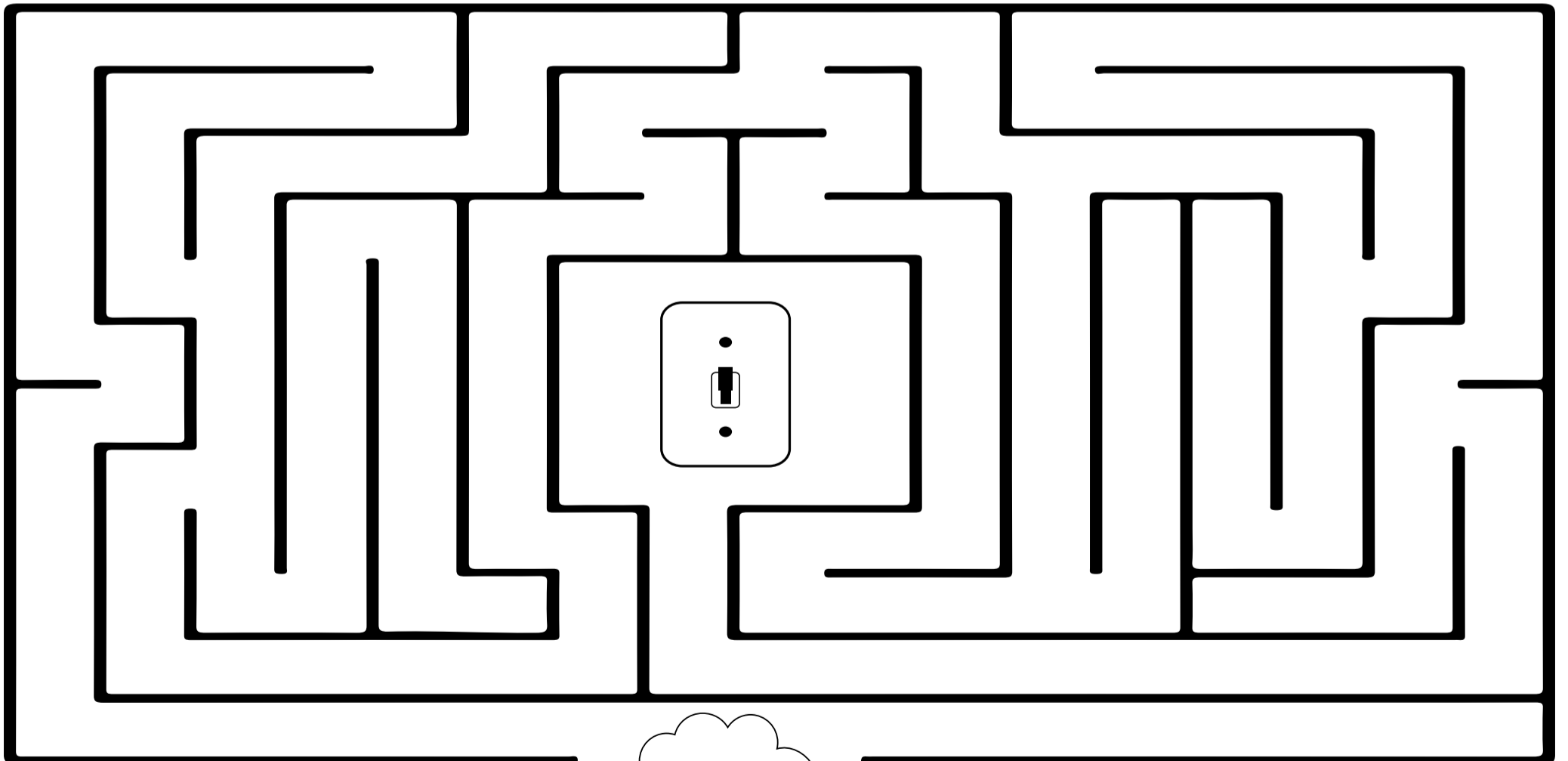

Switch off the light if there is no one in the room.

Ruby and the Powerpals is an e-book available free of charge from www.eskom.co.za/idm



Powering your world

www.eskom.co.za/idm