

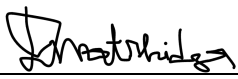







TRANSMISSION
GENERATION CONNECTION CAPACITY
ASSESSMENT OF THE 2024 TRANSMISSION
NETWORK (GCCA – 2024)

Reference No.: GP_22/52

March 2022

Compiled by:	Recommended by:	Supported by:	Approved by:
D Matshidza 	R Marais 	J Machinjike 	S Scheppers 
Chief Technologist			
S Satimburwa 			
Senior Engineer			
B Dlamini 			
Senior Engineer	Senior Manager - Strategic Grid Planning-	General Manager - Grid Planning and Development	Group Executive - Transmission Division
Date: 30/03/2022	Date: 30/03/2022	Date: 31/03/2022	Date: 31 Mar 2022

DISCLAIMER

The publication of the Generation Connection Capacity Assessment of the 2024 transmission network (GCCA-2024) is to inform stakeholders of the potential capacity available on the Eskom transmission network to facilitate connection of generation projects. The Generation Connection Capacity Assessment is based on the information currently available and is subject to change. The information contained in this document does not constitute advice; it is a guideline to assist stakeholders. Eskom Holdings SOC Limited makes no representations regarding the suitability of the information to be used for any other purpose. All information is provided “AS IS” without warranty of any kind and is subject to change without notice. The entire risk arising out of its use remains with the recipient. In no event shall Eskom Holdings SOC Limited be liable for any direct, consequential, incidental, special, punitive, or any other damages whatsoever.

While the GCCA-2024 will be updated periodically, Eskom Holdings SOC Limited makes no representation or warranty as to the accuracy, reliability, validity, or completeness of the information in this document. Eskom does, however, endeavour to release the GCCA based on the best available information at its disposal at all times to ensure that the stakeholders are kept informed about the developments in the transmission network. Thus, the information contained in this document represents the most up-to-date information that was available at the time it was released.

Eskom Transmission Division
Megawatt Park, Maxwell Drive, Sunninghill, Sandton
PO Box 1091, Johannesburg, 2000, South Africa
www.eskom.co.za

ABSTRACT

The launch of the renewable energy independent power producer procurement programme (REIPPPP) attracts a large number of applications from independent power producers (IPPs) for connection to the Eskom grid.

This report, details the available generation connection capacity of the 2024 transmission network with all the projects that are expected to be commissioned by then. This report details the available generation connection capacity for the entire country, and it was compiled per supply area namely; Kwa-Zulu Natal, Mpumalanga, Pelly, Gauteng, Limpopo, North West, Free State, Northern Cape, Western Cape, Hydra Cluster and Eastern Cape.

TABLE OF CONTENTS

Introduction.....	1
Assumptions	1
Methodology	2
1.1. <i>Level 1: Transformer Capacity.....</i>	3
1.2. <i>Level 2: Substation Transfer Capacity</i>	4
1.3. <i>Level 3 and 4: Local and Supply Area Capacity</i>	5
Results	6
1.4. <i>Country Supply Area Capacity</i>	6
1.4.1. GCCA 2024 Southern Supply Areas	7
1.4.2. GCCA 2024 Southern Local Area Capacity	8
1.4.3. GCCA 2024 Northern Supply Areas	9
1.4.4. GCCA 2024 Northern Local Area Capacity	10
1.5. <i>Northern Cape Substation and Transformer Capacity</i>	11
1.6. <i>Northern Cape Summary of Results</i>	11
1.7. <i>Hydra Cluster Substation and Transformer Capacity</i>	14
1.8. <i>Hydra Cluster Summary of Results</i>	14
1.9. <i>Western Cape Substation and Transformer Capacity</i>	16
1.10. <i>Western Cape Summary of Results</i>	16
1.11. <i>Eastern Cape Substation and Transformer Capacity.....</i>	19
1.12. <i>Eastern Cape Summary of Results.....</i>	19
1.13. <i>Free State Substation and Transformer Capacity.....</i>	21
1.14. <i>Free State Summary of Results.....</i>	21
1.15. <i>North West Substation and Transformer Capacity</i>	26
1.16. <i>North West Summary of Results</i>	26
1.17. <i>Kwa Zulu Natal Substation and Transformer Capacity</i>	29
1.18. <i>Kwa Zulu Natal Summary of Results</i>	29
1.19. <i>Gauteng Substation and Transformer Capacity.....</i>	34
1.20. <i>Gauteng Summary of Results.....</i>	34

1.21.	<i>Mpumalanga Substation and Transformer Capacity</i>	38
1.22.	<i>Mpumalanga Summary of Results</i>	38
1.23.	<i>Limpopo Substation and Transformer Capacity</i>	41
1.24.	<i>Limpopo Summary of Results</i>	41
	Committed Available Capacity	45
1.25.	<i>BQ Issued & Valid</i>	45
1.26.	<i>BQ to be Issued</i>	45
	Conclusion	46
	Development Team	46
	Annexure A: Western Cape Supply Area IPPs	47
	Annexure B: Great Northern Cape Area IPPs	48
	Annexure C: Hydra Cluster Supply Area IPPs	49
	Annexure D: Eastern Cape Supply Area IPPs	50
	Annexure E: Eastern Cape Supply Area IPPs	50
	Annexure F: North West Supply Area IPPs	51
	Annexure G: Limpopo Supply Area IPPs	51
	Annexure H: KZN Supply Area IPPs	51

TABLE OF FIGURES

Figure 1: Generation connection capacity limit hierarchy.	2
Figure 2: Transformer capacity assessment.....	3
Figure 3: Substation transfer capacity assessment	4
Figure 4: Area limit calculation	5
Figure 5: Generation connection capacity in the country supply areas	6
Figure 6: Generation connection capacity in the southern six supply areas.....	7
<i>Figure 7: Supply area and local area generation connection capacity</i>	8
<i>Figure 8: Generation connection capacity in the northern supply areas</i>	9
<i>Figure 9: Supply area and local area generation connection capacity</i>	10

Figure 10: Northern Cape supply area generation connection capacity.....	11
Figure 11: Hydra cluster supply area generation connection capacity	14
Figure 12: Western Cape supply area generation connection capacity	16
Figure 13: Eastern Cape supply area generation connection capacity	19
Figure 14: Free State supply area generation connection capacity	21
Figure 15: North West supply area generation connection capacity	26
Figure 16: Kwa Zulu Natal supply area generation connection capacity	29
Figure 17: Gauteng supply area generation connection capacity	34
Figure 18: Mpumalanga supply area generation connection capacity	38
Figure 19: Limpopo supply area generation connection capacity	41
Figure 20: Graphic diagram showing BQ issued and valid	45
Figure 21: Graphic diagram showing BQ to be issued.....	46

TABLE OF TABLES

Table 1: REIPPPP BW6 required procurement by generation technology type	1
Table 2: Northern Cape summary of results	12
Table 3: Hydra cluster summary of results	15
Table 4: Western Cape summary of results	17
Table 5: Eastern Cape summary of results	20
Table 6: Free State summary of results.....	22
Table 7: North West summary of results	27
Table 8: Kwa Zulu Natal summary of results	30
Table 9: Gauteng summary of results	35
Table 10: Mpumalanga summary of results.....	39
Table 11: Limpopo summary of results	42
Table 12: Western Cape Supply Area IPPs.....	47
Table 13: Great Northern Cape Area IPPs	48
Table 14: Hydra Cluster Supply Area IPPs.....	49
Table 15: Eastern Cape Supply Area IPPs.....	50
Table 16: Free State Supply Area IPPs.....	50
Table 17: Northwest Supply Area IPPs	51
Table 18: Limpopo Supply Area IPPs.....	51
Table 19: KZN Supply Area IPPs	51

Introduction

The launch of the renewable energy independent power producer procurement programme (REIPPPP) attracts a large number of applications from independent power producers (IPP) for connection to the Eskom grid.

To be considered in the REIPPPP, IPPs go through a bidding process where they indicate the amount of power they can supply and the feasibility of supplying this power in a cost effective way. The preferred bidders are then selected after this process.

To be successful, IPPs should identify sections of the network with available generation connection capacity where they can connect to. This causes IPPs to constantly contact Eskom with requests for information regarding the available capacity on the network at different nodes. To make information on generation connection capacity within the network readily accessible, Eskom developed the generation connection capacity assessment (GCCA) report.

The revision of the GCCA is triggered by the the announcement of a new REIPPPP bid window. The GCCA–2024 is therefore in response to the announcement of bid window round 6 (BW6) , for which preferred bidders are expected to be connected in year 2024. The network used in the GCCA – 2024 study incorporates all the bid windows up to round 5 (BW5) preferred bidders.

The REIPPPP BW 6 aims to procure 2600 MW of renewable energy generation. Table 1 shows the breakdown per technology type of the generation capacity that will be procured in the REIPPPP BW5.

Table 1: REIPPPP BW6 required procurement by generation technology type

Technology	Capacity (MW)
Wind	1 600
Photovoltaic (PV)	1 000
Total IRP renewable energy for BW5	2 600

Assumptions

The key assumption changes from GCCA-2023 impacting the results are as follows:

- Delayed implementation of customer projects will result in further network constraints by forcing connections directly onto the transmission network.
- Reprioritisation and deferral of transmission projects mainly due to funding constraints will result in the inability to facilitate new connections.

- All the peaking stations (OCGTs) in the Western Cape were set to synchronous condenser (SCO) mode while in the previous GCCA – 2023 they were set to maximum output.
- The 150 MW Risk Mitigation Independent Power Producer Procurement Programme (RMIPPPP) approved at Garona Substation will introduce a 500 MVA 400/132 kV transformer at Garona Substation, subsequently the approved BW 5 124 MW wind farm at Helios substation is accompanied by the reinforcement of the Garona 125MVA 275/132kV with a 500MVA 275/132kV transformer. These transformers will share the 132kV bus bar .
- All the series capacitors in the network in the Northern, Western and Eastern Cape were bypassed.
- The 400kV line thermal ratings that were limited by their equipment ratings were changed line ratings in the network study.
- The North West province was demarcated to show the 400kV network limit and the 275kV limit as the local supply areas.

Methodology

The southern part of the South African transmission network was subdivided into six supply areas covering the area south from the North West and Free State provinces to the Western Cape. The departure from provinces and customer load networks (CLNs) to supply areas is deemed to be more appropriate for this type of assessment. Provincial boundaries may therefore not be respected when referring to provincial names for some supply areas.

The generation connection capacity results are assessed using the hierarchy shown in Figure 1. The generation capacity that can be connected must be restricted by the lowest limit in the hierarchy.

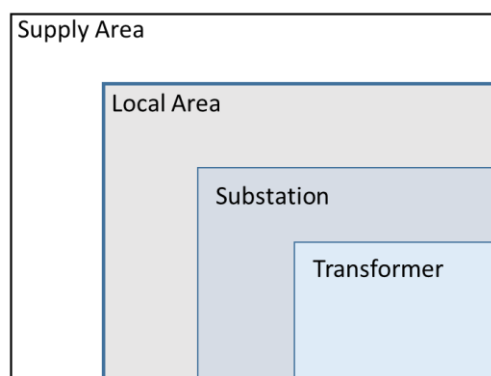

Figure 1: Generation connection capacity limit hierarchy.

1.1. Level 1: Transformer Capacity

At level 1, the local substation transformation capacity is assessed assuming an N-0 level of reliability. The generation connection capacity available is evaluated considering the full transformation capacity and assuming that the generators operate at a 0.95 power factor.

When a generator is connected to the secondary busbar in a substation, the power generated is first absorbed by the local load and the excess is fed upstream through the transformers. The red arrows in Figure 2 depict the flow of power when the generator is connected at a substation.

The capacity of a substation's transformation is fixed, but the substation load varies throughout the day. This means that the lower the load connected at a substation, the lower the generation capacity that can be connected at the substation secondary busbar.

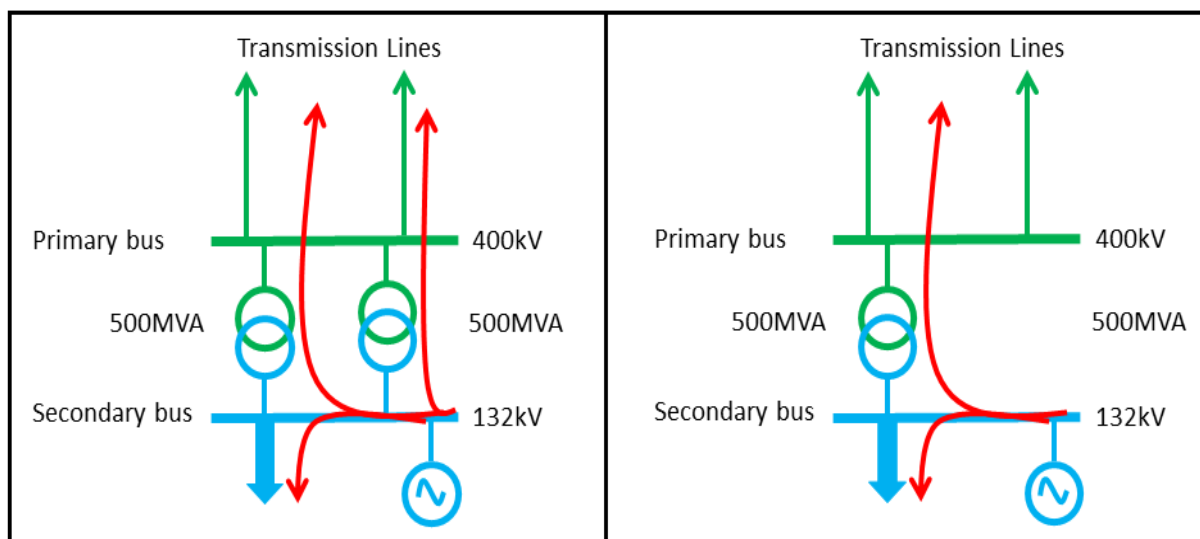

Figure 2: Transformer capacity assessment

1.2. Level 2: Substation Transfer Capacity

At level 2, the substation transfer capacity is evaluated by connecting a generator at each substation primary busbar one at a time, as shown in Figure 3. The network is assessed under all credible N-1 line contingencies.

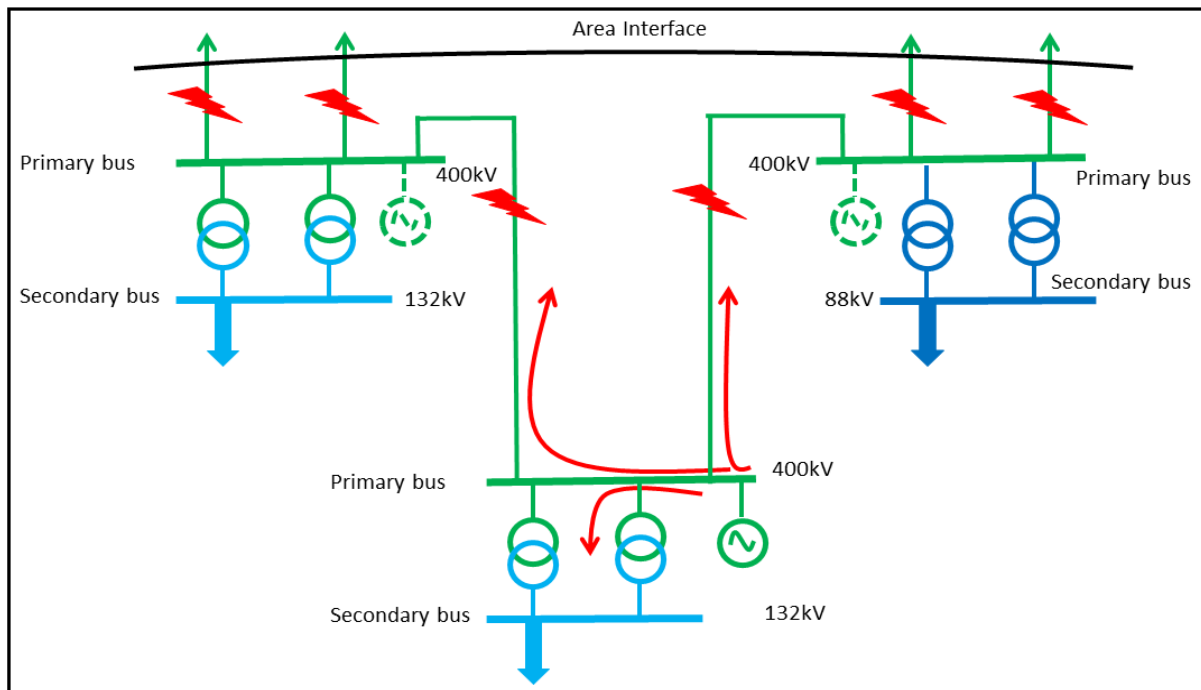

Figure 3: Substation transfer capacity assessment

1.3. Level 3 and 4: Local and Supply Area Capacity

At level 3 and 4, the generation connection capacity is assessed at an area level by scaling all the connected generation in proportion to their values as determined from level 2 (Section 3.3). The available area generation connection capacity is evaluated by connecting generators at each substation's primary busbar as shown in Figure 4.

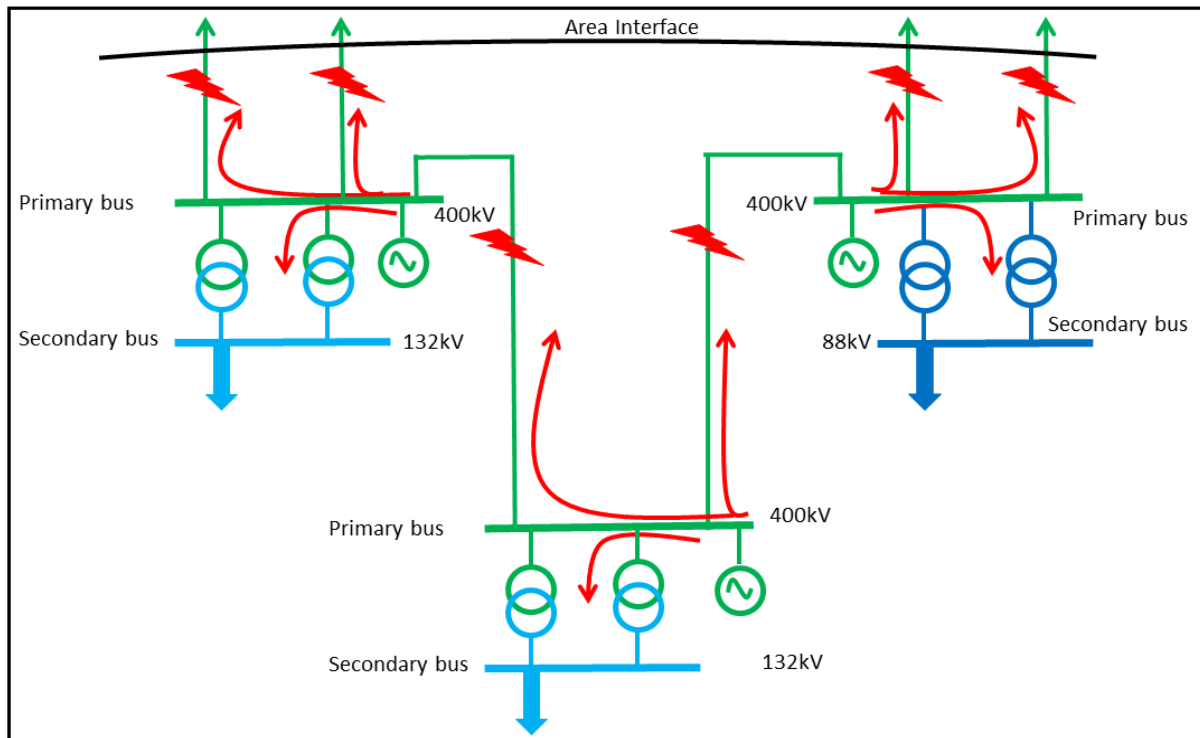

Figure 4: Area limit calculation

Results

1.4. Country Supply Area Capacity

This report considered all the supply areas covering the whole of the South African provinces. Figure 5 indicates that the country supply areas are limited to about 32.4 GW of new generation capacity.

The generation connection capacity available within each supply area is shown in Figure 5.

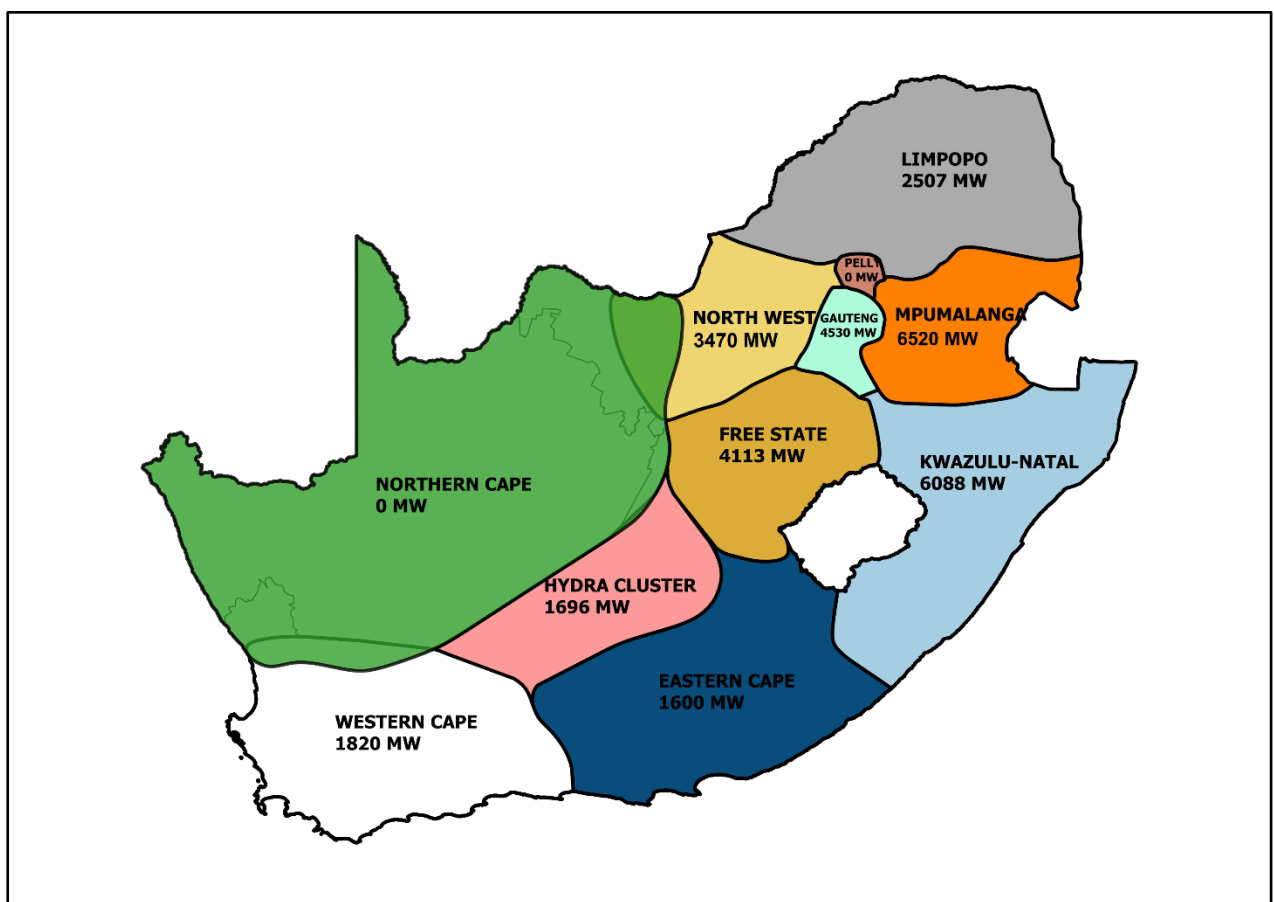

Figure 5: Generation connection capacity in the country supply areas

1.4.1. GCCA 2024 Southern Supply Areas

This section of the report considers six supply areas covering the area south from the North West and Free State provinces to the Western Cape. The six supply areas are limited to about 12.7 GW of generation capacity. However, the Northern Cape power corridors are highly constrained and cannot evacuate additional generation further to what has already been approved. Substantial upstream network strengthening will therefore be required to facilitate new generation capacity. In contrast, the North West supply area has the ability to accommodate about 3.48 GW of generation.

The generation connection capacity available within each supply area is shown in Figure 6.

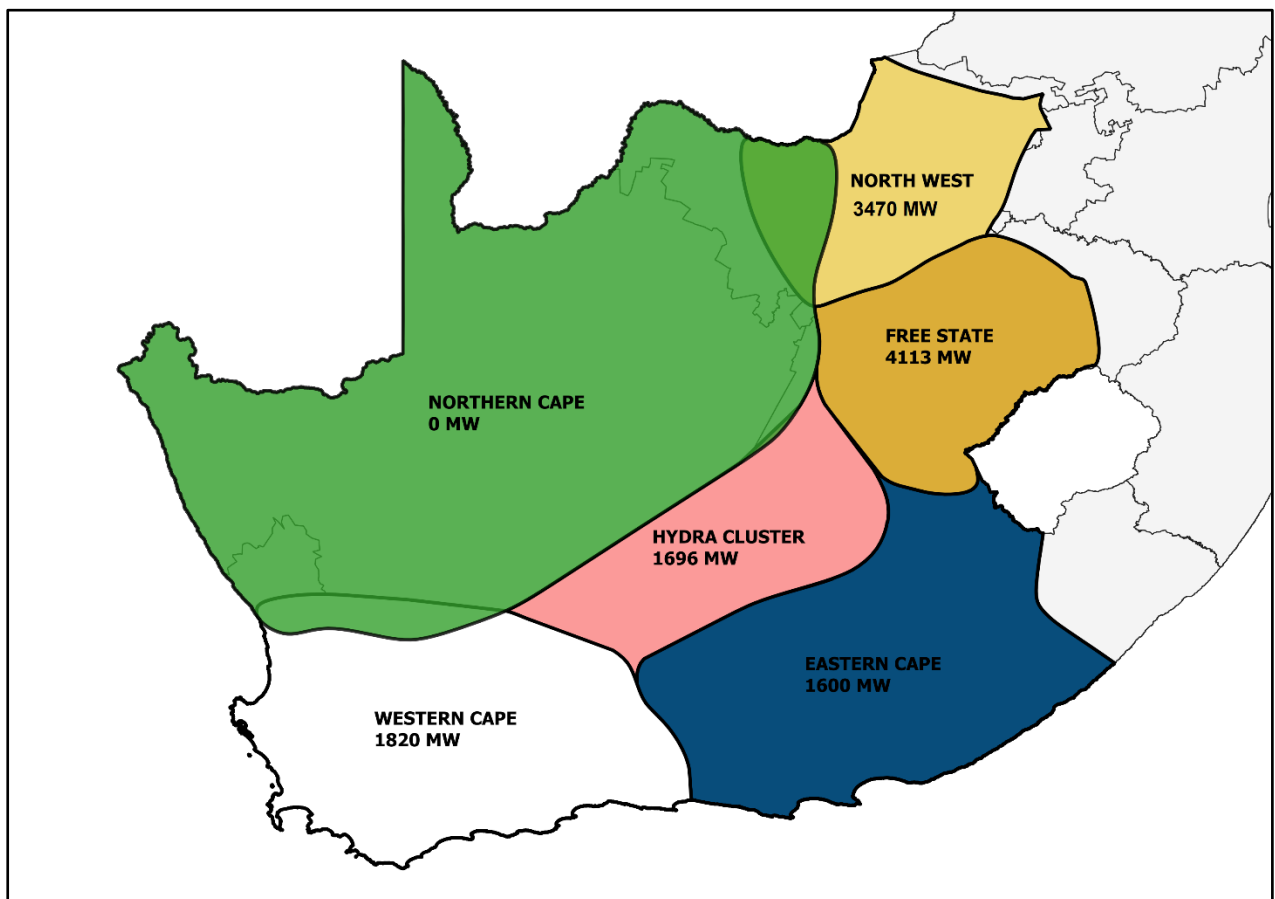

Figure 6: Generation connection capacity in the southern six supply areas

1.4.2. GCCA 2024 Southern Local Area Capacity

The six supply areas consist of local areas, each of which have their own available capacity. Figure 7 shows the generation connection capacity available in each supply area as well as in their respective local areas.

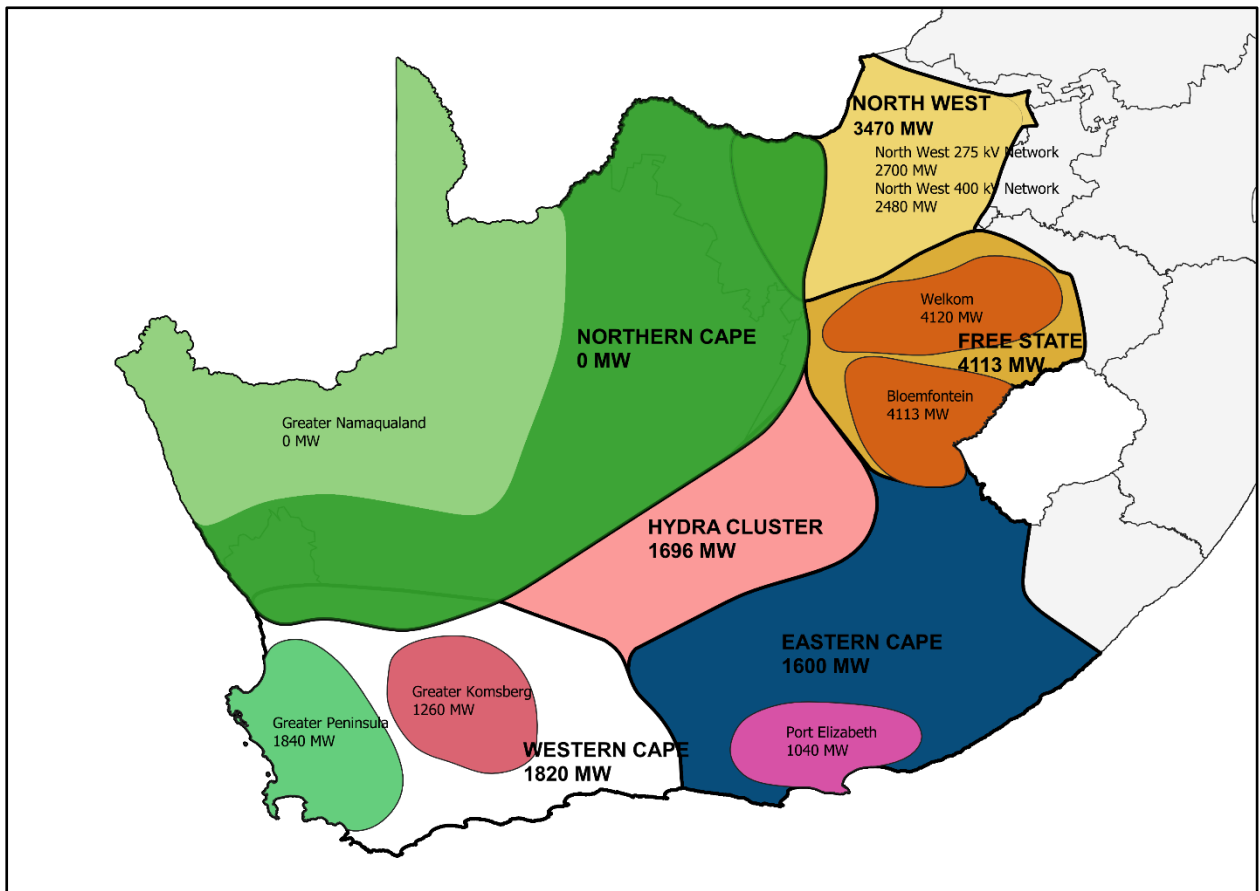

Figure 7: Supply area and local area generation connection capacity

1.4.3. GCCA 2024 Northern Supply Areas

This section of the report considered the five remaining supply areas covering the area north from Kwa Zulu Natal, Gauteng, Mpumalanga Limpopo and Pelly. The supply areas are limited to about 19.6 GW of generation capacity. Mpumalanga has the highest available capacity of 6.5 GW followed by Kwa Zulu Natal with 6.09 GW followed by Gauteng and Limpopo with 4.5 GW and 2.5 GW respectively. However Pelly substation is highly constrained and will require upstream network strengthening to facilitate any generation capacity.

The generation connection capacity available within each supply area is shown in *Figure 8*.

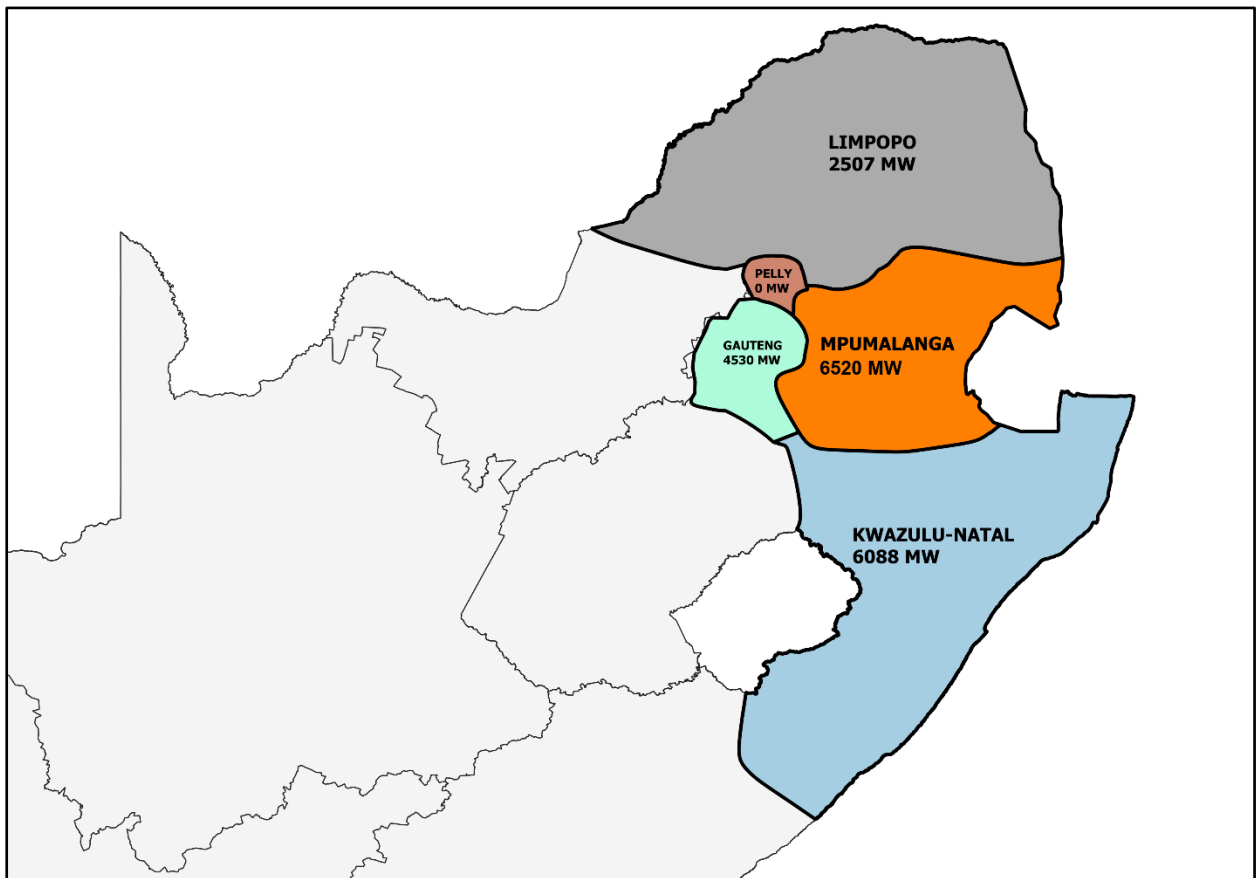

Figure 8: Generation connection capacity in the northern supply areas

1.4.4. GCCA 2024 Northern Local Area Capacity

The five northern supply areas consist of local areas, each of which have their own available capacity. Figure 9 shows the generation connection capacity available in each supply area as well as in their respective local areas.

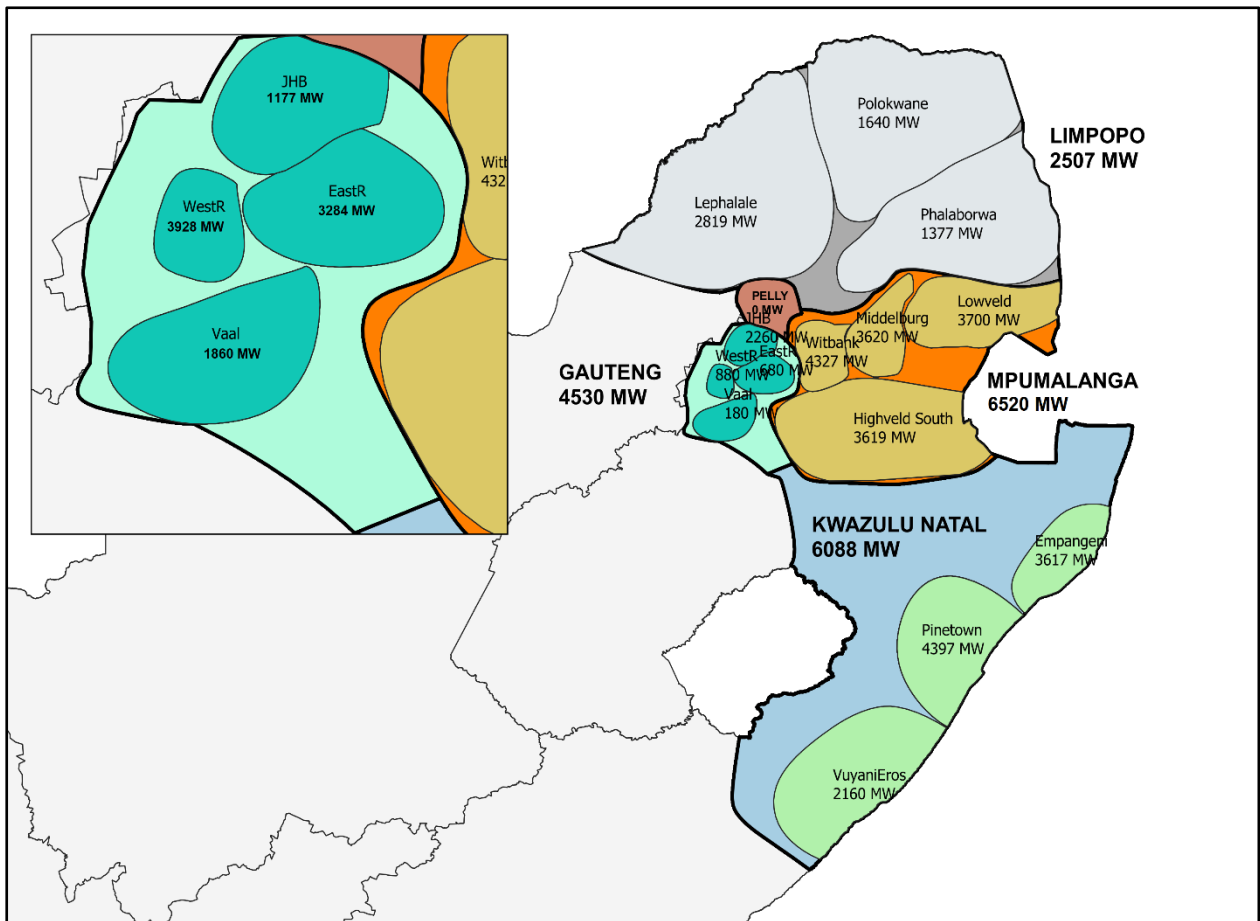

Figure 9: Supply area and local area generation connection capacity

1.5. Northern Cape Substation and Transformer Capacity

Figure 10 shows the substation transfer capacity and transformer capacity within the Northern Cape area.

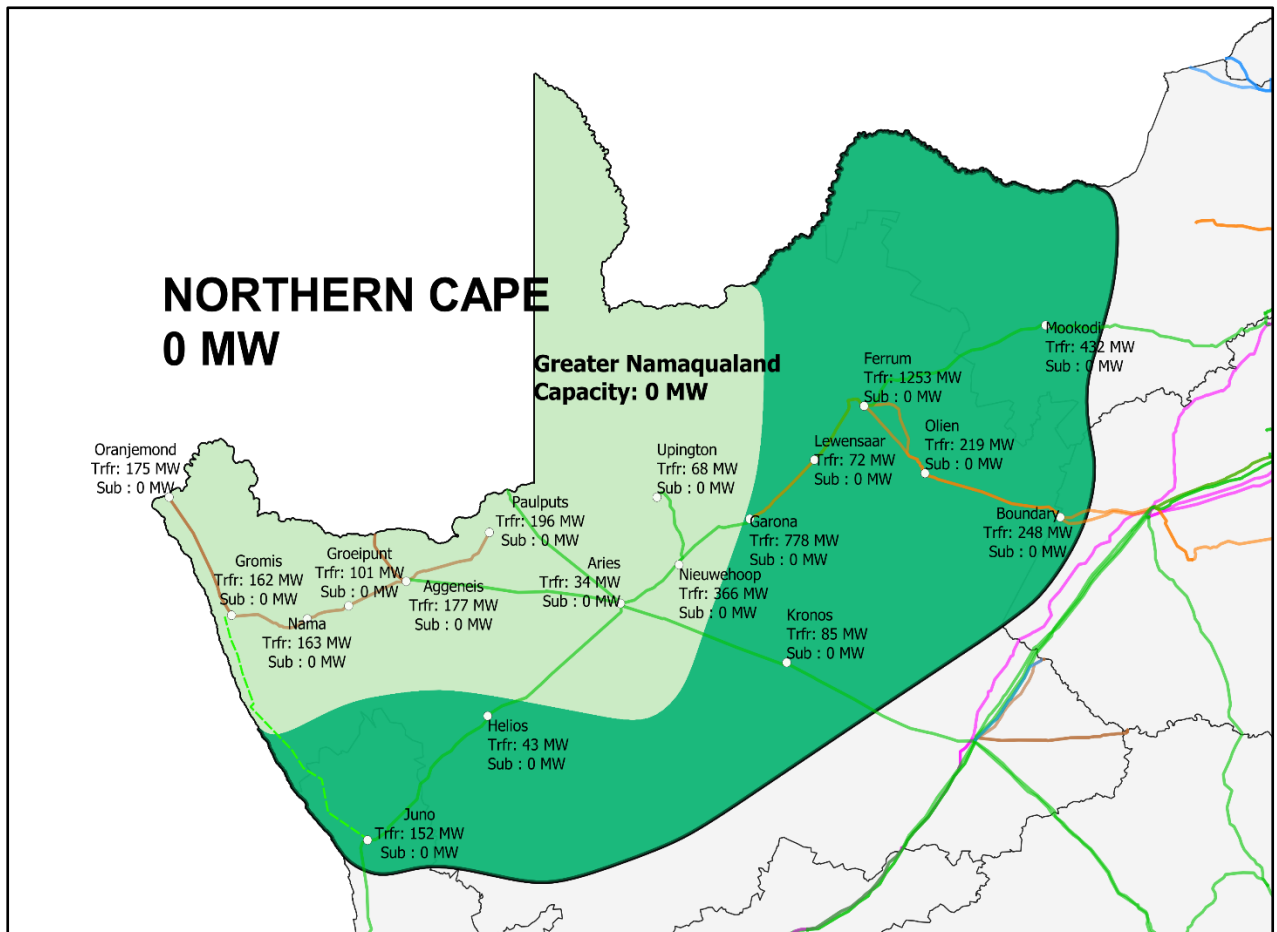

Figure 10: Northern Cape supply area generation connection capacity.

The Northern Cape supply area has transformation capacity at all of the substations, however it does not have substation transfer capacity.

1.6. Northern Cape Summary of Results

Table 2 summarises the available generation connection capacity within the Northern Cape supply area..

Table 2: Northern Cape summary of results

Supply Area	Local Area	Substation	Trfr Size (MVA)	No. of Trfrs	Transformation (kV/kV)	Installed Transformer (MVA)	Load	Solar REIPPP Gen Allocated (MW)	BQ Issued & Valid	Wind REIPPP Gen Allocated (MW)	RMIPPPP (MW)	Transformer Limit (MW)	Substation Limit (MW)	Local Area Limit (MW)	Supply Area Limit (MW)
Northern Cape	Greater Namaqualand	Aggeneis	40	3	220/66	80	28	40	0	0	0	64	0	0	0
			315	2	400/220	630	-	0	0	0	0	177	0		
		Gromis	315	1	400/220	315	-	0	0	0	0	162	0		
			40	2	220/66	80	3.38	0	0	0	0	79	0		
		Groeipunt	250	1	220/132	250	0	0	0	137	0	101	0		
		Paulputs	250	1	220/132	375	26	284.7	0	0	0	98	0		
			125	1					0	0	0		0		
		Oranjemond	80	2	220/66	160	23	0	0	0	0	175	0		
		Nama	80	2	220/66	160	11	0	0	0	0	163	0		
		Upington	500	1	400/132	500	52	383.9	0	0	75	68	0		
		Nieuwehoop	250	1	400/132	750	0	0	0	0	347	366	0		
			500	1					0	0					
	Aries	45	1	400/22	45	1.1	9.65	0	0	0	34	0			
	Northern Cape	Kronos	250	1	400/132	565	21	235	0	238	0	85	0	0	
			315	1					0						
Olien		150	1	275/132	400	98	258.9	0	0	0	219	0			

Supply Area	Local Area	Substation	Trfr Size (MVA)	No. of Trfrs	Transformation (kV/kV)	Installed Transformer (MVA)	Load	Solar REIPPP Gen Allocated (MW)	BQ Issued & Valid	Wind REIPPP Gen Allocated (MW)	RMIPPPP (MW)	Transformer Limit (MW)	Substation Limit (MW)	Local Area Limit (MW)	Supply Area Limit (MW)
			250	1					0						
		Ferrum	500	2	400/132	1500	152	324	0	0	0	1253	0		
			250	2	275/132				0				0		
			80	3	132/66	240	60	0	0	0	0	288			
		Garona	500	1	275/132	1000	28	50	0	0	150	778	0		
			500	1	400/132				0				0		
		Lewensaar	40	1	275/22	40	34	0	0	0	0	72	0		
		Boundary	250	2	275/132	500	108	335	0	0	0	248	0		
		Helios	500	1	400/132	500	1.75	75	0	400	0	2	0		
			45	1	400/22	45			0		0	43			
		Juno	120	2	400/132	240	32.84	9	0	100	0	152	0		
			40	2	132/66	80		0	0	0	0	76			
		Mookodi	250	2	400/132	500	32	75	0	0	0	432	0		

1.7. Hydra Cluster Substation and Transformer Capacity

Figure 11 shows the substation transfer capacity and transformer capacity within the Hydra cluster.

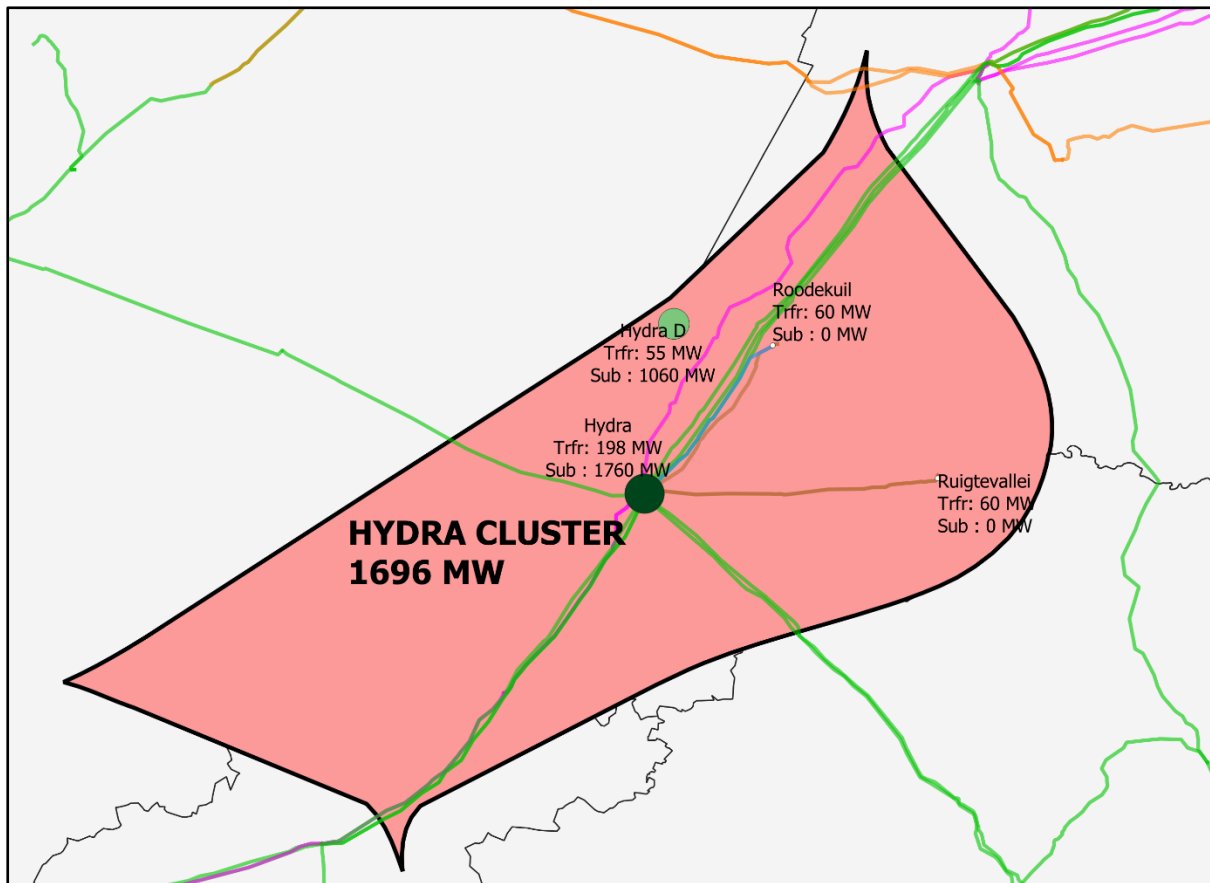

Figure 11: Hydra cluster supply area generation connection capacity

The Hydra cluster has transformation capacity available at all of the substations, however substation transfer capacity is highly constrained at Roodekuil and Rigtevallei.

1.8. Hydra Cluster Summary of Results

Table 3 summarises the available generation connection capacity within the Hydra cluster supply area.

Table 3: Hydra cluster summary of results

Supply Area	Local Area	Substation	Trfr Size (MVA)	No. of Trfrs	Transformation (kV/kV)	Installed Transformer (MVA)	Load	Solar REIPPP Gen Allocated (MW)	BQ Issued & Valid	Wind REIPPP Gen Allocated (MW)	RMIPPPP (MW)	Transformer Limit (MW)	Substation Limit (MW)	Local Area Limit (MW)	Supply Area Limit (MW)
Hydra Cluster	Hydra Cluster	Hydra	240	2	400/132	480	50	319	0	79	0	108	1760	1696	1696
			500	1	400/132	500	0	75	0	235	75	90			
			315	2	400/220	630		0	0	0	0	49	0		
		Roodekuil	125	1	220/132	125	5	0	0	0	0	60	0		
		Hydra D	500	1	400/132	500	0	0	0	420	0	55	1060		
		Ruigtevallei	250	1	220/132	250	38.93	75	0	0	0	60	0		
			20	2	132/66	40	6	0	3.6	0	0	40			

1.9. Western Cape Substation and Transformer Capacity

Figure 12 shows the substation transfer capacity and transformer capacity within the Western Cape supply area.

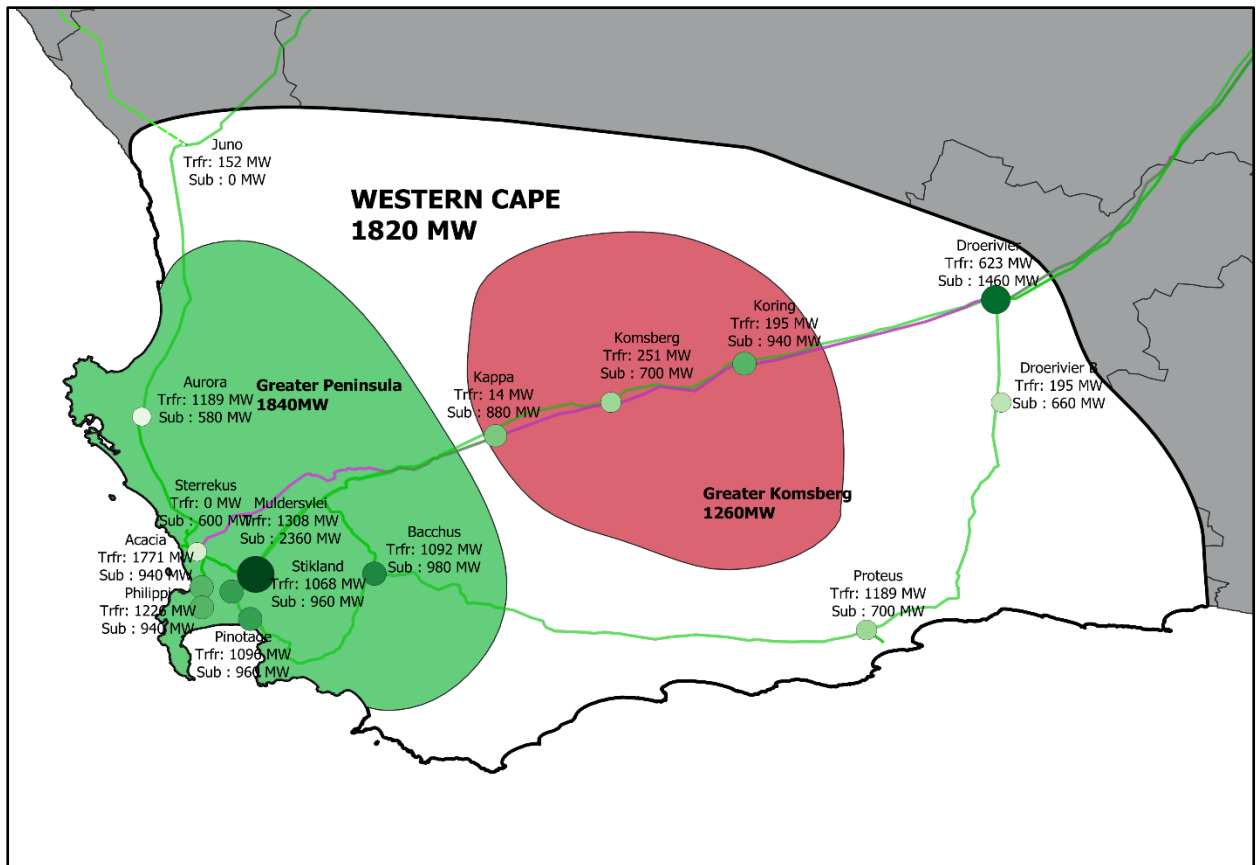

Figure 12: Western Cape supply area generation connection capacity

Except for Sterrekus, the Western Cape supply area has transformation capacity at all the substations. Furthermore, the Western Cape supply area has available transfer capacity at all the substations.

1.10. Western Cape Summary of Results

Table 4 summarises the available generation connection capacity within the Western Cape supply area.

Table 4: Western Cape summary of results

Supply Area	Local Area	Substation	No. of Trfrs	Trfr Size (MVA)	Transformation (kV/kV)	Installed Transformer (MVA)	Load	Solar REIPPP Gen Allocated (MW)	BQ Issued & Valid	Wind REIPPP Gen Allocated (MW)	RMIPPPP (MW)	Transformer Limit (MW)	Substation Limit (MW)	Local Area Limit (MW)	Supply Area Limit (MW)	
Western Cape	Greater Komsberg	Komsberg	2	500	400/132	1000	0	0	0	699.2	0	250.8	700	1260	1820	
		Kappa	1	500	400/132	500	0	225	0	108	128	14	880			
		Koring	1	500	400/132	500		0	0	280		195	940			
	Greater Peninsula	Stikland	2	500	400/132	1000	118	0	0	0	0	0	1068	960		1840
		Aurora	1	500	400/132	500	213	89	0	159.4	320	594.6	580			
			2	250	400/132	500								0		
		Acacia	3	500	400/132	1500	346	0	0	0	0	0	1771	940		
		Pinotage	2	500	400/132	1000	146	0	0	0	0	0	1096	960		
		Muldersvlei	3	500	400/132	1500	21	0	0	0	138	0	1308	2360		
		Bacchus	2	500	400/132	1000	236	36	0	58	0	0	1092	980		
		Sterrekus	1	2000	765/400	2000	-	0	0	0	0	0	-	600		
Philippi	2	500	400/132	1000	276	0	0	0	0	0	1226	940				

Supply Area	Local Area	Substation	No. of Trfrs	Trfr Size (MVA)	Transformation (kV/kV)	Installed Transformer (MVA)	Load	Solar REIPPP Gen Allocated (MW)	BQ Issued & Valid	Wind REIPPP Gen Allocated (MW)	RMIPPPP (MW)	Transformer Limit (MW)	Substation Limit (MW)	Local Area Limit (MW)	Supply Area Limit (MW)
	Western Cape	Droerivier	1	250	400/132	250	28	0	0	0	0	311.25	1460	1820	
			1	125	400/132	125		0	0	73					
		Droerivier B	1	500	400/132	500		0	0	280	0	195	660		
		Proteus	2	500	400/132	1000	239	0	0	0	0	1189	700		

1.11. Eastern Cape Substation and Transformer Capacity

Figure 13 shows the substation transfer capacity and transformer capacity within the Eastern Cape supply area.

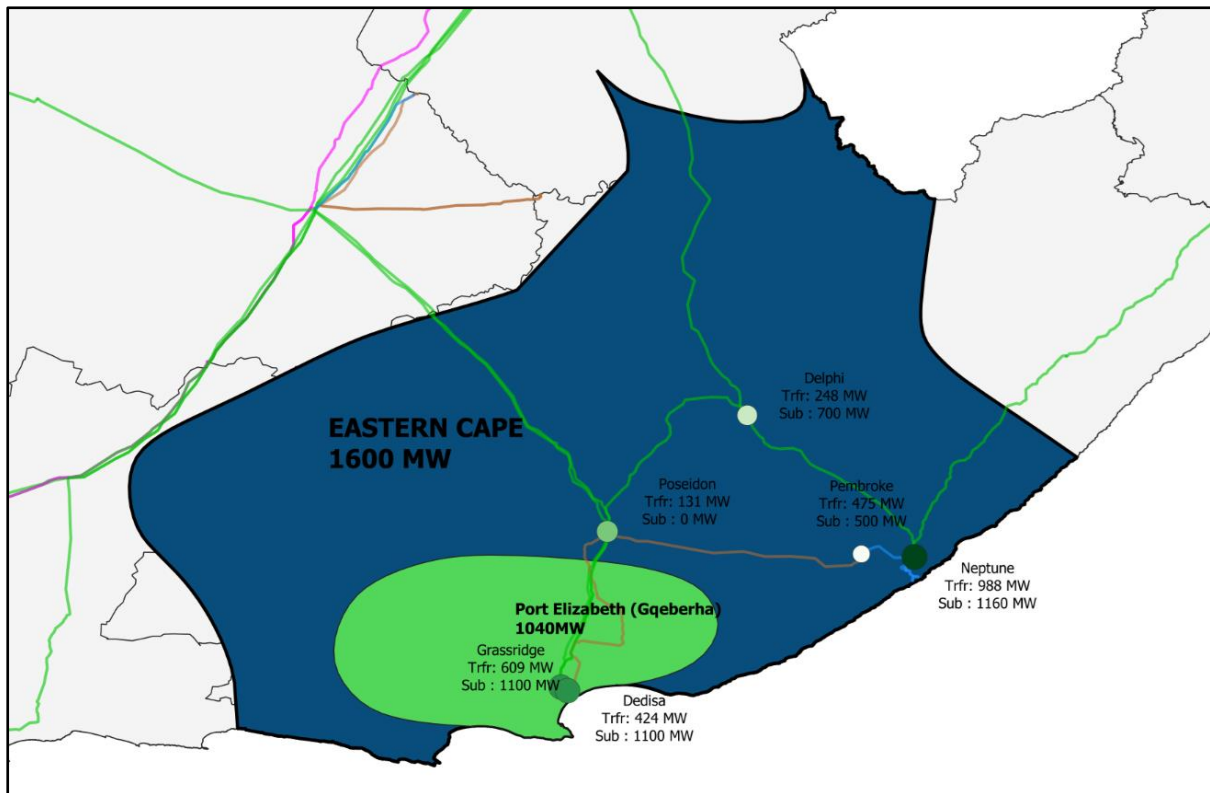

Figure 13: Eastern Cape supply area generation connection capacity

The Eastern Cape supply area has transformation transfer capacity available at all the substations, however the substation transfer capacity is highly constrained at Poseidon.

1.12. Eastern Cape Summary of Results

Table 5 summarises the available generation connection capacity within the Eastern Cape supply area.

Table 5: Eastern Cape summary of results

Supply Area	Local Area	Substation	No. of Trfrs	Trfr Size (MVA)	Transformation (kV/kV)	Installed Transformer (MVA)	Load	Solar REIPPP Gen Allocated (MW)	BQ Issued & Valid	Wind REIPPP Gen Allocated (MW)	RMIPPPP (MW)	Transformer Limit (MW)	Substation Limit (MW)	Local Area Limit (MW)	Supply Area Limit (MW)		
Eastern Cape	Gqeberha	Grassridge	2	500	400/132	1000	302	0	0	804	80	368	1100	1040	1600		
			2	360	220/132	720		0	0	0	144	1100					
		Dedisa	2	500	400/132	1000	122	0	0	0	648	424	1100				
	Eastern Cape	Eastern Cape	Neptune	2	500	400/132	1000	38	0	0	0	0	988	1160		1600	
			Delphi	2	125	400/132	250	110	0	0	100	0	247.5	700			
			Pembroke	1	500	400/132	500	0	0	0	0	0	475	500			
			Pembroke	2	250	220/132	500	43	0	0	53	0	465	240			
			Poseidon	2	500	400/220	1000	0	0	0	0	0	0	-			0
				1	500	400/132	500	0	0	0	0	484	0	0			0
			2	125	220/132	250	47	0	0	0	164	0	120.5	0			
			1	80	220/66	80	17	0	0	0	0	0	93	0			
			1	40	220/66	40	0	0	0	0	0	0	38	0			

1.13. Free State Substation and Transformer Capacity

Figure 14 shows the substation transfer capacity and transformer capacity within the Free State supply area.

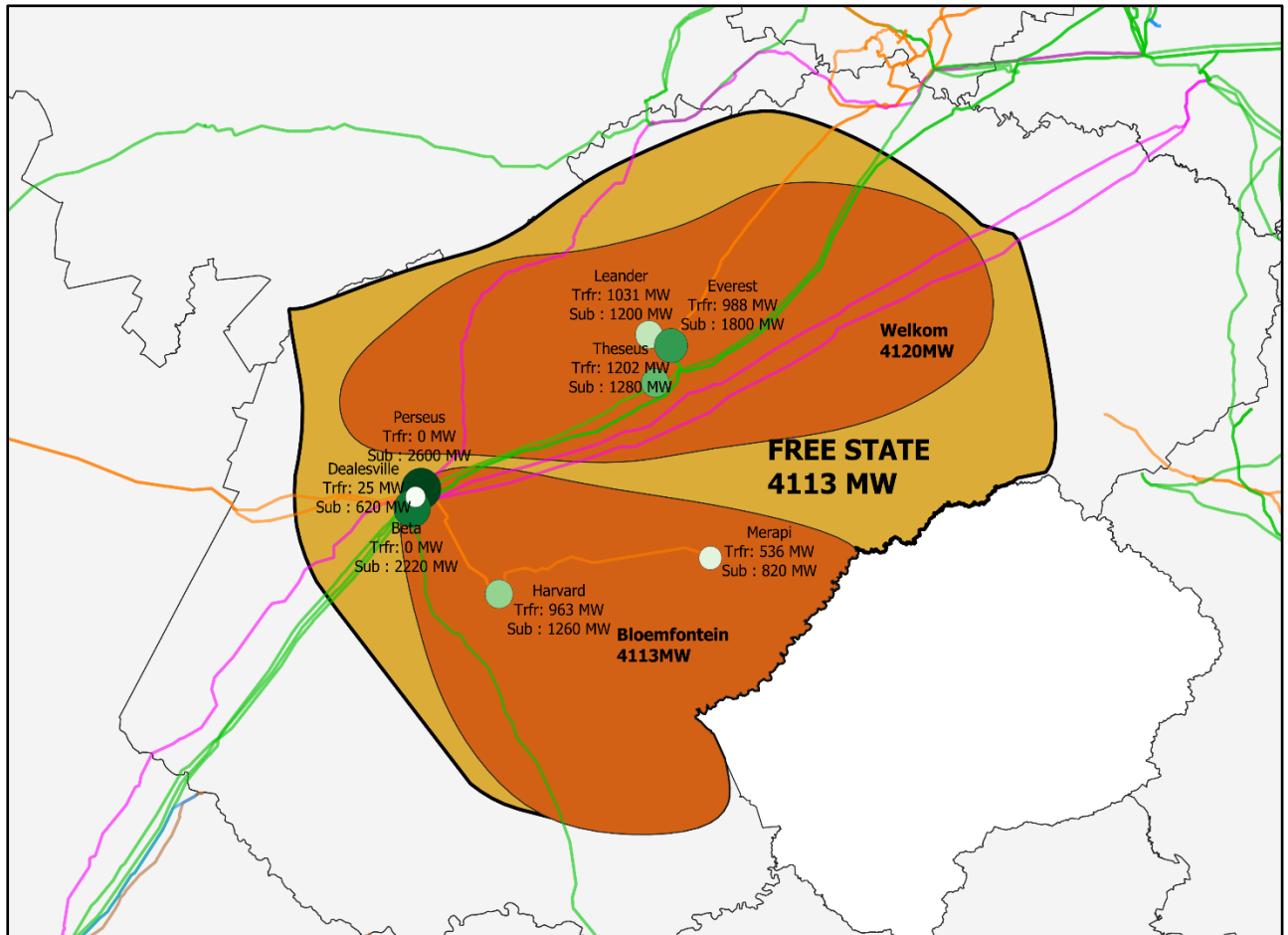

Figure 14: Free State supply area generation connection capacity

The Free State supply area has transformation capacity available at all substation except at Perseus and Beta and substation transfer capacity available at all the substations.

1.14. Free State Summary of Results

Table 6 summarises the available generation connection capacity within the Free State supply area.

Table 6: Free State summary of results

Supply Area	Local Area	Substation	No. of Trfrs	Trfr Size (MVA)	Transformation (kV/kV)	Installed Transformer (MVA)	Load	Solar REIPPP Gen Allocated (MW)	BQ Issued & Valid	Wind REIPPP Gen Allocated (MW)	RMIPPPP (MW)	Transformer Limit (MW)	Substation Limit (MW)	Local Area Limit (MW)	Supply Area Limit (MW)
Free State	Bloemfontein	Perseus	1	2000	765/400	2000	0	0	0	0	0	0	2600	4113	4113
			2	400	400/275	800	0	0	0	0	0	0	2880		
			1	800	400/275	800	0	0	0	0	0	0	0		
		Beta	2	2000	765/400	4000	0	0	0	0	0	0	2220		
		Dealsville	1	500	400/132	500	0	450	0	0	0	25	620		
		Harvard	2	500	275/132	1000	151.67	139	0	0	0	963	1260		

Supply Area	Local Area	Substation	No. of Trfrs	Trfr Size (MVA)	Transformation (kV/kV)	Installed Transformer (MVA)	Load	Solar REIPPP Gen Allocated (MW)	BQ Issued & Valid	Wind REIPPP Gen Allocated (MW)	RMIPPPP (MW)	Transformer Limit (MW)	Substation Limit (MW)	Local Area Limit (MW)	Supply Area Limit (MW)	
		Merapi	2	250	275/132	500	61.5	0	0	0	0	536	820			
	Welkom	Leander	2	500	400/132	1000	156.1	75	0	0	0	1031	1200			4120
		Theseus	2	500	400/132	1000	252.36	0	0	0	0	1202	1280			
		Sorata	1	250	275/132	250	43.1	0	0	0	0	280	340			
		Everest	2	500	275/132	1000	38.4	0	0	0	0	988	1800			

Supply Area	Local Area	Substation	No. of Trfrs	Trfr Size (MVA)	Transformation (kV/kV)	Installed Transformer (MVA)	Load	Solar REIPPP Gen Allocated (MW)	BQ Issued & Valid	Wind REIPPP Gen Allocated (MW)	RMIPPPP (MW)	Transformer Limit (MW)	Substation Limit (MW)	Local Area Limit (MW)	Supply Area Limit (MW)
Free State	Bloemfontein	Perseus	1	2000	765/400	2000	0	0	0	0	0	0	2600	4113	4113
			2	400	400/275	800	0	0	0	0	0	0	2880		
			1	800	400/275	800	0	0	0	0	0	0	0		
		Beta	2	2000	765/400	4000	0	0	0	0	0	0	2220		
		Dealsville	1	500	400/132	500	0	0	0	0	0	25	620		
		Harvard	2	500	275/132	1000	151.67	64	0	0	0	963	1260		

Supply Area	Local Area	Substation	No. of Trfrs	Trfr Size (MVA)	Transformation (kV/kV)	Installed Transformer (MVA)	Load	Solar REIPPP Gen Allocated (MW)	BQ Issued & Valid	Wind REIPPP Gen Allocated (MW)	RMIPPPP (MW)	Transformer Limit (MW)	Substation Limit (MW)	Local Area Limit (MW)	Supply Area Limit (MW)
	Welkom	Merapi	2	250	275/132	500	61.5	0	0	0	0	536	820	4120	
		Leander	2	500	400/132	1000	156.1	0	0	0	0	1031	1200		
		Theseus	2	500	400/132	1000	252.36	0	0	0	0	1202	1280		
		Sorata	1	250	275/132	250	43.1	0	0	0	0	280	340		
		Everest	2	500	275/132	1000	38.4	0	0	0	0	988	1940		

1.15. North West Substation and Transformer Capacity

Figure 15 shows the substation transfer capacity and transformer capacity within the North West supply area.

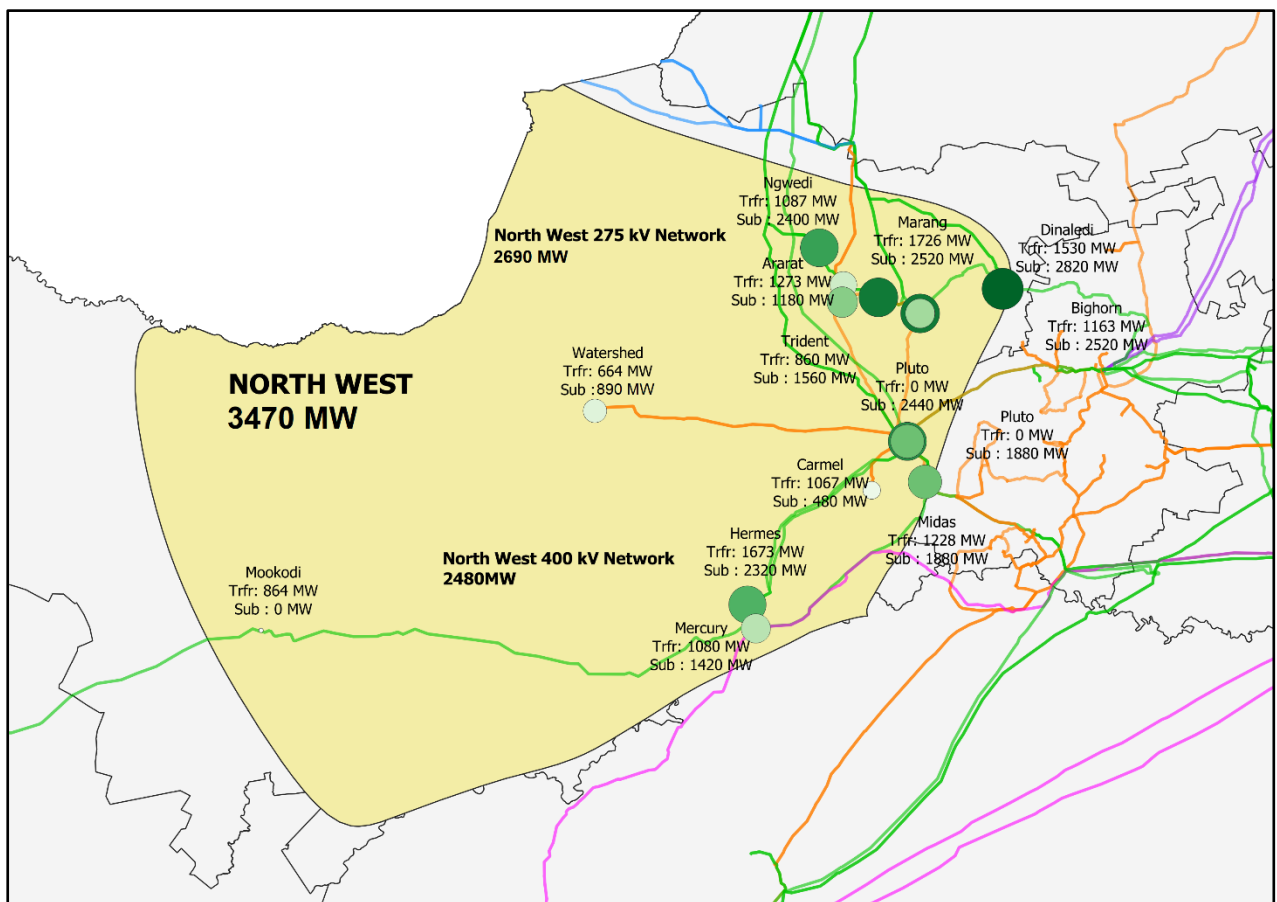

Figure 15: North West supply area generation connection capacity

The North West has transformation capacity and substation transfer capacity available at all the substations except for Mookodi and Pluto.

1.16. North West Summary of Results

Table 7 summarises the available generation connection capacity within the North West supply area.

Table 7: North West summary of results

Supply Area	Local Area	Substation	Trfr Size (MVA)	No. of Trfrs	Transformation (kV/kV)	Installed Transformer (MVA)	Load	Solar REIPPPP Gen Allocated (MW)	BQ Issued & Valid	Wind REIPPPP Gen Allocated (MW)	RMIPPPP (MW)	Transformer Limit (MW)	Substation Limit (MW)	Local Area Limit (MW)	Supply Area Limit (MW)	
North West	North West 400 kV Network	Dinaledi	500	3	400/132	1500	105	0	0	0	0	1530	2820	2480	3470	
		Marang	315	4	400/88	1260	529	0	0	0	0	1726	2520			
		Ngwedi	500	2	400/132	1000	137	0	0	0	0	1087	2400			
		Midas	500	2	400/132	1000	278	0	0	0	0	1228	1880			
		Pluto	800	1	400/275	1550	0	0	0	0	0	0	0			2440
			750	1		0										
		Bighorn	800	2	400/275	1600	0	0	0	0	0	0	2520			
		Mookodi	250	2	400/132	500	32	75	0	0	0	432	0			
		Hermes	500	3	400/132	1500	248	0	0	0	0	1673	2320			
			180	1	132/88	340	38	0	0	0	0	361				
			160	1	132/88			0	0	0	0					
		Mercury	500	2	400/132	1000	198	67.9	0	0	0	1080	1420			
	North West 275 kV Network	Ararat	315	3	275/88	945	375	0	0	0	0	1273	1180	2690		
		Pluto	800	1	400/275	1550	0	0	0	0	0	0	1880			
			750	1												

Supply Area	Local Area	Substation	Trfr Size (MVA)	No. of Trfrs	Transformation (kV/kV)	Installed Transformer (MVA)	Load	Solar REIPPP Gen Allocated (MW)	BQ Issued & Valid	Wind REIPPP Gen Allocated (MW)	RMIPPPP (MW)	Transformer Limit (MW)	Substation Limit (MW)	Local Area Limit (MW)	Supply Area Limit (MW)
		Bighorn	315	3	275/88	945	272	7	0	0	0	1163	1440		
		Trident	315	2	275/88	630	261	0		0	0	860	1560		
		Watershed	315	2	275/88	630	140	75		0	0	664	890		
			180	2	132/88	360	24	0	10	0	0	346			
			250	1	275/132	250	0	0	0	0	0	238			
		Carmel2A	500	1	275/132	1000	117	0	0	0	0	1067	480		
		Carmel2B	500	1					0				480		

1.17. Kwa Zulu Natal Substation and Transformer Capacity

Figure 16 shows the substation transfer capacity and transformer capacity within the Kwa Zulu Natal supply area.

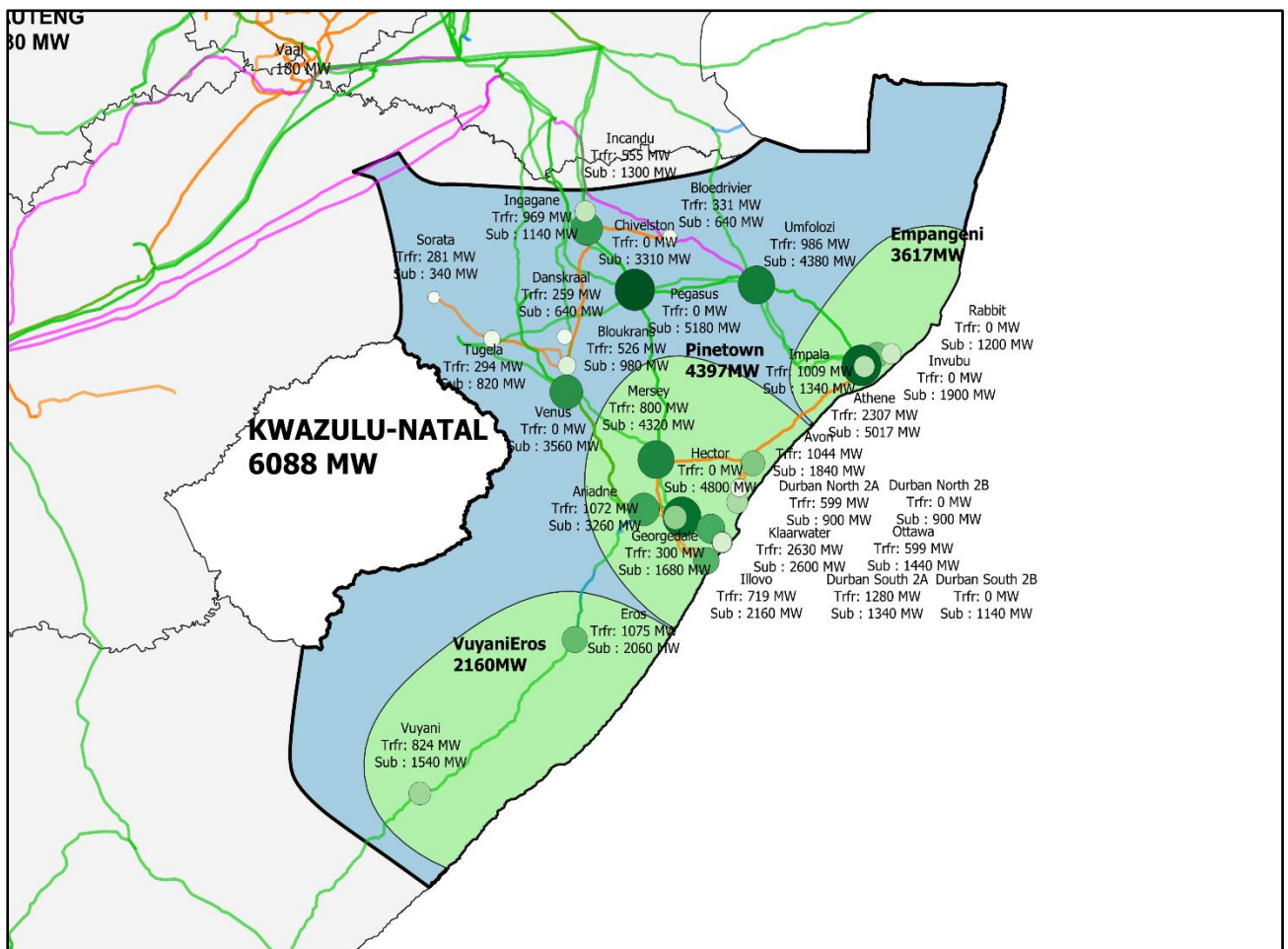

Figure 16: Kwa Zulu Natal supply area generation connection capacity

1.18. Kwa Zulu Natal Summary of Results

Table 8 summarises the available generation connection capacity within the Kwa Zulu Natal supply area.

Table 8: Kwa Zulu Natal summary of results

Supply Area	Local Area	Substation	No. of Trfrs	Trfr Size (MVA)	Transformation (kV/kV)	Installed Transformer (MVA)	TOSM Load	Solar REIPPP Gen Allocated (MW)	BQ Issued & Valid	Wind REIPPP Gen Allocated (MW)	RMIPPPP (MW)	Transformer Limit (MW)	Substation Limit (MW)	Local Area Limit (MW)	Supply Area Limit (MW)	
KwaZulu Natal	Empangeni	Invubu	3	800	400/275	2400	0	0	0	0	0	-	1900	3617	6088	
			-	-	275	-	-	-	0	-	-	-	2040			
		Athene	4	500	400/132	2000	410	0	3	0	0	2307	5017			
		Impala	4	250	275/132	1000	59	0	0	0	0	1009	1340			
		Rabbit	-	-	275	-	-	-	0	-	-	-	1200			
	Pinetown	Mersey		3	800	400/275	2400	0	0	0	0	0	-	4320		4397
				3	250	275/132	750	88	0	3	0	0	797	3097		
		Ariadne	2	500	400/132	1000	122	0	0	0	0	1072	3260			
		Hector		3	800	400/275	2400	0	0	0	0	0	-	4800		
				-	-	275	0	0	0	0	0	0	-	3240		
		Klaarwater		2	315	275/132	1130	242	0	0	0	0	1315	2600		
				2	250	275/132				0						

Supply Area	Local Area	Substation	No. of Trfrs	Trfr Size (MVA)	Transformation (kV/kV)	Installed Transformer (MVA)	TOSM Load	Solar REIPPP Gen Allocated (MW)	BQ Issued & Valid	Wind REIPPP Gen Allocated (MW)	RMIPPPP (MW)	Transformer Limit (MW)	Substation Limit (MW)	Local Area Limit (MW)	Supply Area Limit (MW)
		Georgedale	1	250	275/132	250	62	0	0	0	0	300	1680		
		Illovo	2	250	275/132	500	344	0	0	100	0	719	2160		
		Avon	3	250	275/132	750	331	0	0	0	0	1044	1840		
		Ottawa	2	315	275/132	630	0	0	0	0	0	599	1440		
		Durban South 2A	4	315	275/132	1260	83	0	0	0	0	1280	1340		
		Durban South 2B											1140		
		Lotus Park 2A	1	315	275/132	315		0	0	0	0	299	760		
		Lotus Park 2B							0				760		
		Durban North 2A	2	315	275/132	630	0	0	0	0	0	599	900		

Supply Area	Local Area	Substation	No. of Trfrs	Trfr Size (MVA)	Transformation (kV/kV)	Installed Transformer (MVA)	TOSM Load	Solar REIPPP Gen Allocated (MW)	BQ Issued & Valid	Wind REIPPP Gen Allocated (MW)	RMIPPPP (MW)	Transformer Limit (MW)	Substation Limit (MW)	Local Area Limit (MW)	Supply Area Limit (MW)	
		Durban North 2B							0				900			
	VuyaniEros	Vuyani	2	400	400/132	800	64	0	0	0	0	824	0	0		
		Eros	2	500	400/132	1000	125	0	0	0	0	1075	0			
	Newcastle Cluster	Tugela	2	180	275/132	360	16	64	0	0	0	294	820	3282		
		Bloedrivier	2	160	275/88	320	27	0	0	0	0	331	640			
		Ingagane	2	500	275/88	1000	19	0	0	0	0	969	1140			
		Danskraal	2	125	275/132	250	22	0	0	0	0	259	640			
		Bloukrans	2	250	275/132	500	51	0	0	0	0	526	980			
		Chivelston		1	800	400/275	800	0	0	0	0	0	-		3310	
					-	275	0	0	0	0	0	0	-		960	

Supply Area	Local Area	Substation	No. of Trfrs	Trfr Size (MVA)	Transformation (kV/kV)	Installed Transformer (MVA)	TOSM Load	Solar REIPPP Gen Allocated (MW)	BQ Issued & Valid	Wind REIPPP Gen Allocated (MW)	RMIPPPP (MW)	Transformer Limit (MW)	Substation Limit (MW)	Local Area Limit (MW)	Supply Area Limit (MW)
		Incandu	1	500	400/132	500	80	0	0	0	0	555	1300		
		Sorata	1	250	275/132	250	43.1	0	0	0	0	280	340		
		Venus	2	800	400/275	1600	0	0	0	0	0	-	3560		
			-	-	275	0	0	0	0	0	0	0	1400		
		Umfoloji	1	315	400/88	315	42	0	0	0	0	493	4380		
			1	160		160									
		Pegasus	-	-	400		-	-	0	-	-	-	5180		

1.19. Gauteng Substation and Transformer Capacity

Figure 17 shows the substation transfer capacity and transformer capacity within Gauteng supply area.

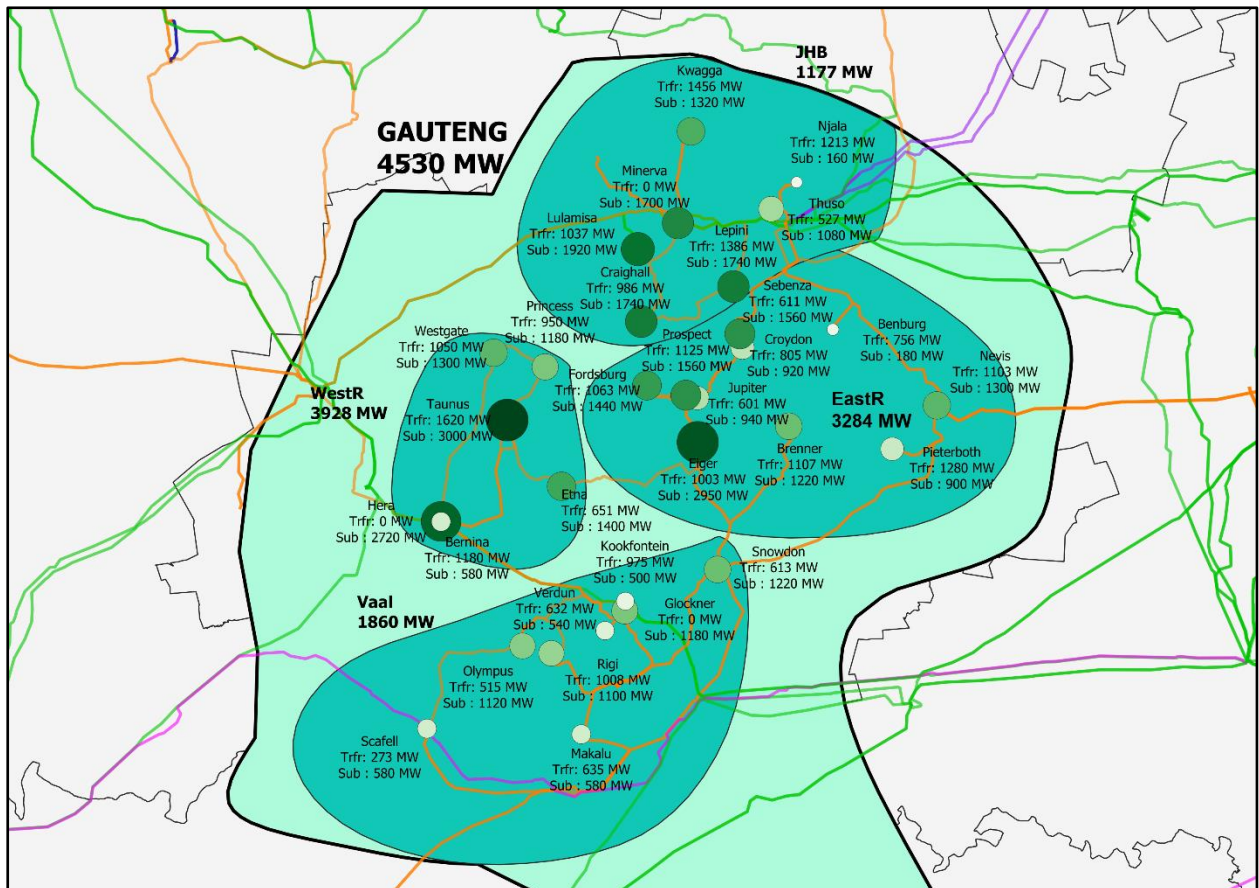

Figure 17: Gauteng supply area generation connection capacity

1.20. Gauteng Summary of Results

Table 9 summarises the available generation connection capacity within the Gauteng supply area.

Table 9: Gauteng summary of results

Supply Area	Local Area	Substation	Transformation (kV/kV)	No. of Trfrs	Trfr Size (MVA)	Installed Transformer (MVA)	TOSM Load	Solar REIPPP Gen Allocated (MW)	BQ Issued & Valid	Wind REIPPP Gen Allocated (MW)	RMIPPPP (MW)	Transformer Limit (MW)	Substation Limit (MW)	Local Area Limit (MW)	Supply Area Limit (MW)
Gauteng	Johannesburg	Lulamisa	400/88	3	315	945	139	0	0	0	0	1037	1920	1177	4530
		Minerva	400/275	4	800	3200	-	0	0	0	0	-	1700		
			275	-	-	-	-	-	0	-	-	-	1700		
		Njala	275/132	4	250	1000	263	0	0	0	0	1213	160		
		Thuso	400/132	2	250	500	52	0	0	0	0	527	1080		
		Craighall	275/88	3	315	945	88	0	0	0	0	986	1740		
		Kwagga	275/132	4	300	1200	316	0	0	0	0	1456	1320		
		Lepini	275/88	4	315	1260	189	0	0	0	0	1386	1740		
		Lomond	275/88	2	315	630	90	50	3.5	0	0	635	937		
		Delta	275/88	3	250	750	100	0	0	0	0	812	1460		
	East West	Jupiter	275/88	3	180	540	88	0	0	0	0	601	940	3284	
		Croydon	275/132	3	250	750	93	0	0	0	0	805	920		
		Esselen	275/132	2	180	360	64	0	8	0	0	636	132		
275/132			1	250	250										

Supply Area	Local Area	Substation	Transformation (kV/kV)	No. of Trfrs	Trfr Size (MVA)	Installed Transformer (MVA)	TOSM Load	Solar REIPPP Gen Allocated (MW)	BQ Issued & Valid	Wind REIPPP Gen Allocated (MW)	RMIPPPP (MW)	Transformer Limit (MW)	Substation Limit (MW)	Local Area Limit (MW)	Supply Area Limit (MW)
			275/88	2	315	630	85	0		0	0	683			
		Prospect	275/88	4	250	1000	175	0	0	0	0	1125	1560		
		Fordsburg	275/88	4	250	1000	113	0	0	0	0	1063	1440		
		Eiger	275/88	3	315	945	105	0	0	0	0	1003	2950		
		Pieterboth	275/88	4	315	1260	83	0	0	0	0	1280	900		
		Brenner	275/88	3	315	945	209	0	0	0	0	1107	1220		
		Benburg	275/132	3	250	750	43	0	0	0	0	756	180		
		Sebenza	275/88	2	315	630	12	0	0	0	0	611	1560		
		Nevis	275/132	2	500	1000	153	0	0	0	0	1103	1300		
	Westrand	Hera	400/275	2	800	1600	-	0	0	0	0	-	2720	3928	
			275	-	-	-	-	-	0	-	-	-	2900		
		Princess	275/88	3	315	945	52	0	0	0	0	950	1180		
		Taunus	275/132	3	500	1500	195	0	0	0	0	1620	3000		
		Westgate	275/132	2	500	1000	100	0	0	0	0	1050	1300		
		Etna	275/88	2	315	630	53	0	0	0	0	651	1400		
		Bernina	275/132	2	500	1000	230	0	0	0	0	1180	580		
	VaalSasolburg	Glockner	400/275	3	800	2400	-	0	0	0	0	-	1180	1860	

Supply Area	Local Area	Substation	Transformation (kV/kV)	No. of Trfrs	Trfr Size (MVA)	Installed Transformer (MVA)	TOSM Load	Solar REIPPP Gen Allocated (MW)	BQ Issued & Valid	Wind REIPPP Gen Allocated (MW)	RMIPPPP (MW)	Transformer Limit (MW)	Substation Limit (MW)	Local Area Limit (MW)	Supply Area Limit (MW)
			275	-	-	-	-	-	0	-	-	-	940		
		Kookfontein	275/88	3	315	945	77	0	0	0	0	975	500		
		Verdun	275/88	2	315	630	33	0	0	0	0	632	540		
		Snowdon	275/88	3	160	480	157	0	0	0	0	613	1220		
		Makalu	275/88	4	160	640	27	0	0	0	0	635	580		
		Rigi	275/88	3	315	945	110	0	0	0	0	1008	1100		
		Scafell	275/132	2	135	270	17	0	0	0	0	273	580		
		Olympus	275/132	2	250	500	40	0	0	0	0	515	1120		
			275/33	4	120	480	3	0	0	0	0	459			

1.21. Mpumalanga Substation and Transformer Capacity

Figure 18 shows the substation transfer capacity and transformer capacity within Mpumalanga supply area.

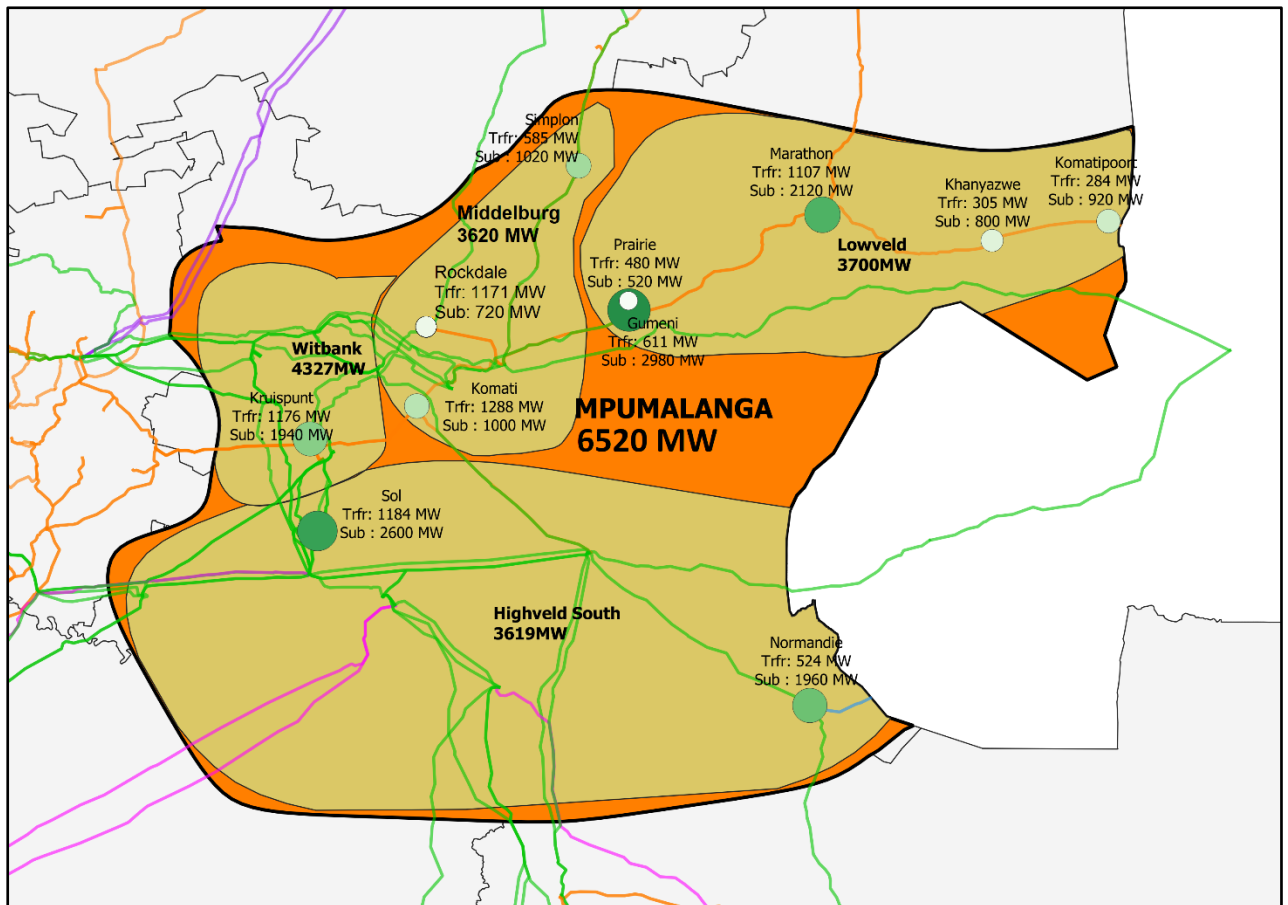

Figure 18: Mpumalanga supply area generation connection capacity

1.22. Mpumalanga Summary of Results

Table 10 summarises the available generation connection capacity within the Mpumalanga supply area.

Table 10: Mpumalanga summary of results

Supply Area	Local Area	Substation	Transformation (kV/kV)	No. of Trfrs	Trfr Size (MVA)	Installed Transformer (MVA)	TOSM Load	Solar REIPPPP Gen Allocated (MW)	BQ Issued & Valid	Wind REIPPPP Gen Allocated (MW)	RMIPPPP (MW)	Transformer Limit (MW)	Substation Limit (MW)	Local Area Limit (MW)	Supply Area Limit (MW)		
Mpumalanga	Highveld South	Sol	400/132	2	500	1000	234	0	0	0	0	1184	2600	3619	6520		
			400/132	2	500	1000	0	0		0	0						
		Normandie	400/132	2	250	500	49	0	0	0	0	0	524			1960	
			400/88	2	160	320	20	0	0	0	0	0	324				
		Zeus	400	2	2000	4000	-	-	0	-	-	-	2764				
		Alpha	400	3	2000	6000	-	-	0	-	-	-	2520				
	Middelburg	Simplon	275/132	2	250	500	110	0	0	0	0	0	585	1020		3620	
		Rockdale	275/132	2	500	1000	191	0	0	0	0	0	1141				720
			132/88	2	80	160	114	0	0	0	0	0	323				
			132/88	2	30	60		0	0	0	0	0	0				
		Komati	275/132	2	250	500	50	0	0	0	0	0	644				1000
			275/132	1	125	125		0	0	0	0	0	0				
			275/88	1	160	160		9	0	0	0	0	0				
	Witbank	Vulcan	400/132	2	500	1000	381	0	0	0	0	0	2139	4398		4327	
			400/132	2	300	600											
			400/132	1	250	250											

Supply Area	Local Area	Substation	Transformation (kV/kV)	No. of Trfrs	Trfr Size (MVA)	Installed Transformer (MVA)	TOSM Load	Solar REIPPP Gen Allocated (MW)	BQ Issued & Valid	Wind REIPPP Gen Allocated (MW)	RMIPPPP (MW)	Transformer Limit (MW)	Substation Limit (MW)	Local Area Limit (MW)	Supply Area Limit (MW)
	Lowveld	Kruispunt	275/132	4	250	1000	226	0	0	0	0	1176	1940	3700	
		Gumeni	400/132	1	500	500	136	0	0	0	0	611	2980		
		Khanyazwe	275/132	1	250	250	67	0	0	0	0	305	800		
		Marathon	275/132	2	500	1000	157	0	0	0	0	1107	2120		
		Komatipoort	275/132	2	125	250	46	0	0	0	0	284	920		
		Prairie	275/88	2	240	480	24	0	0	0	0	480	520		

1.23. Limpopo Substation and Transformer Capacity

Figure 19 shows the substation transfer capacity and transformer capacity within Limpopo supply area.

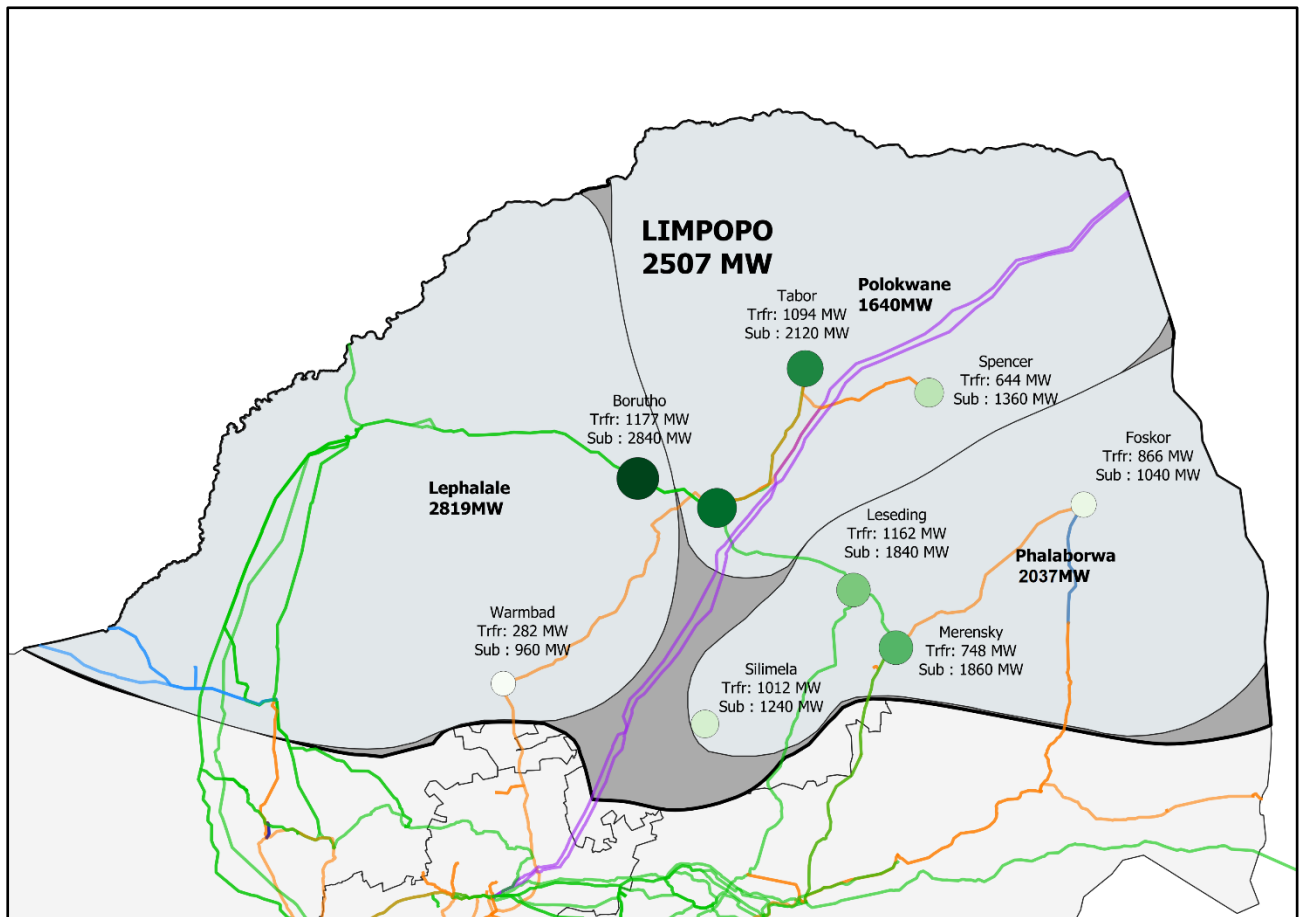

Figure 19: Limpopo supply area generation connection capacity

1.24. Limpopo Summary of Results

Table 11 summarises the available generation connection capacity within the Limpopo supply area.

Table 11: Limpopo summary of results

Supply Area	Local Area	Substation	No. of Trfrs	Trfr Size (MVA)	Transformation (kV/kV)	Installed Transformer (MVA)	Load	Solar REIPPP Gen Allocated (MW)	BQ Issued & Valid	Wind REIPPP Gen Allocated (MW)	RMIPPPP (MW)	Transformer Limit (MW)	Substation Limit (MW)	Local Area Limit (MW)	Supply Area Limit (MW)
Limpopo	Polokwane	Tabor	1	500	400/132	500	172	28	0	0	0	1094	1700	1640	2507
			2	250	275/132	500	0	0	0	0	0		1140		
		Witkop	2	400	400/275	800	-	0	0	0	0		1780		
			3	500	400/132	1500	234	30	0	0	0	1629	1540		
		Spencer	2	250	275/132	500	169	0	0	0	0	644	1040		
	Lephalale	Matimba	2	250	400/132	500	50	30	120	0	0	375	680	2819	
		Borutho	2	500	400/132	1000	227	0	0	0	0	1177	760		

Supply Area	Local Area	Substation	No. of Trfrs	Trfr Size (MVA)	Transformation (kV/kV)	Installed Transformer (MVA)	Load	Solar REIPPP Gen Allocated (MW)	BQ Issued & Valid	Wind REIPPP Gen Allocated (MW)	RMIPPPP (MW)	Transformer Limit (MW)	Substation Limit (MW)	Local Area Limit (MW)	Supply Area Limit (MW)	
		Spitskop	2	800	400/275	1600	-	0	0	0	0		1280			
			2	315	275/88	630	326	0	0	0	0	925	-			
			3	500	400/132	1500	132	0	10	0	0	1447	1070			
		Warmbad	2	125	275/132	250	44	0	0	0	0	282	700			
			2	48	132/66	96	17	0	0	0	0	108				
	Phalaborwa	Acornhoek	2	125	275/132	250	99	0	3	0	200	137	1377			2037
		Foskor	3	250	275/132	750	153	0	0	0	0	866	1040			

Supply Area	Local Area	Substation	No. of Trfrs	Trfr Size (MVA)	Transformation (kV/kV)	Installed Transformer (MVA)	Load	Solar REIPPP Gen Allocated (MW)	BQ Issued & Valid	Wind REIPPP Gen Allocated (MW)	RMIPPPP (MW)	Transformer Limit (MW)	Substation Limit (MW)	Local Area Limit (MW)	Supply Area Limit (MW)
		Leseding	2	500	400/132	1000	212	0	0	0	0	1162	1480		
		Merensky	1	500	400/132	500	273	0	0	0	0	748	1880		
			2	250	275/132	500		0	0	0	0	475	2320		
		Silimela	2	500	400/132	1000	62	0	0	0	0	1012	1160		

Committed Available Capacity

Committed available capacity refers to all the recently released BQ (Budget Quotation) to IPP (Independent Power Producers), at the time of publication of this report there were ten (10) BQ that were already issued and twenty-three (23) BQ to be issued.

1.25. BQ Issued & Valid

Figure 20 below shows the BQ that were released before the publication of this report. The released BQ's are all under 100MW and they span across different provinces.

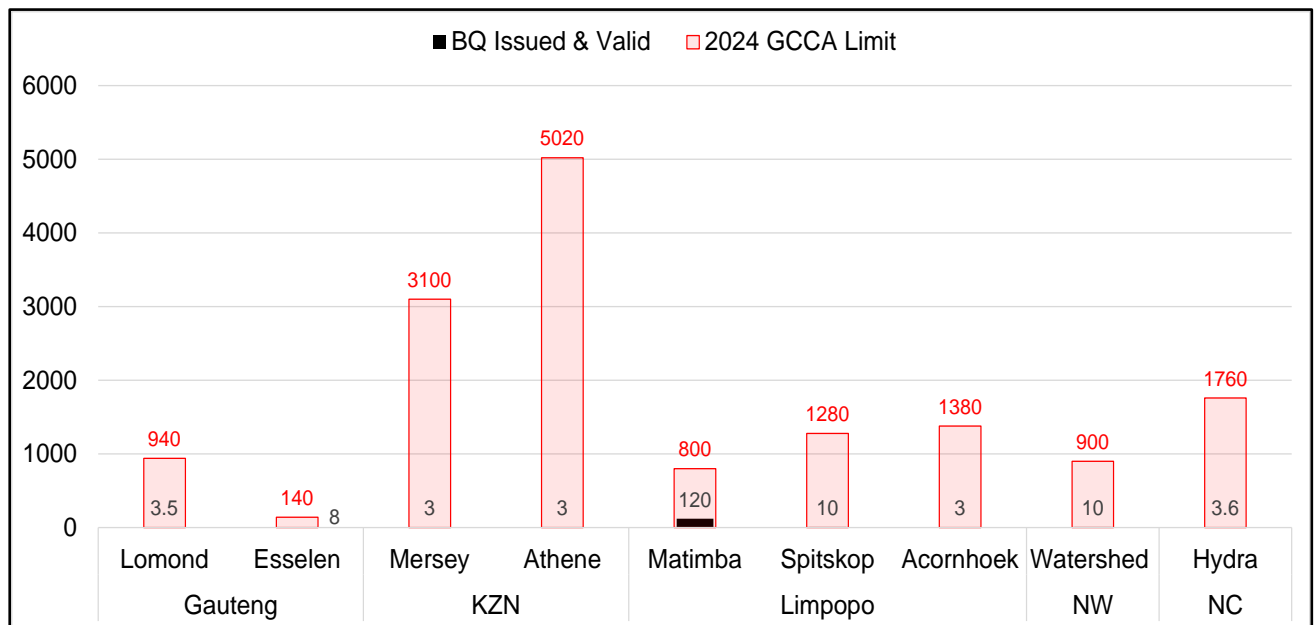

Figure 20: Graphic diagram showing BQ issued and valid

1.26. BQ to be Issued

Figure 21 below shows the BQ's to be released to IPP's, the total of twenty-three (23) were still outstanding during the publication of this report.

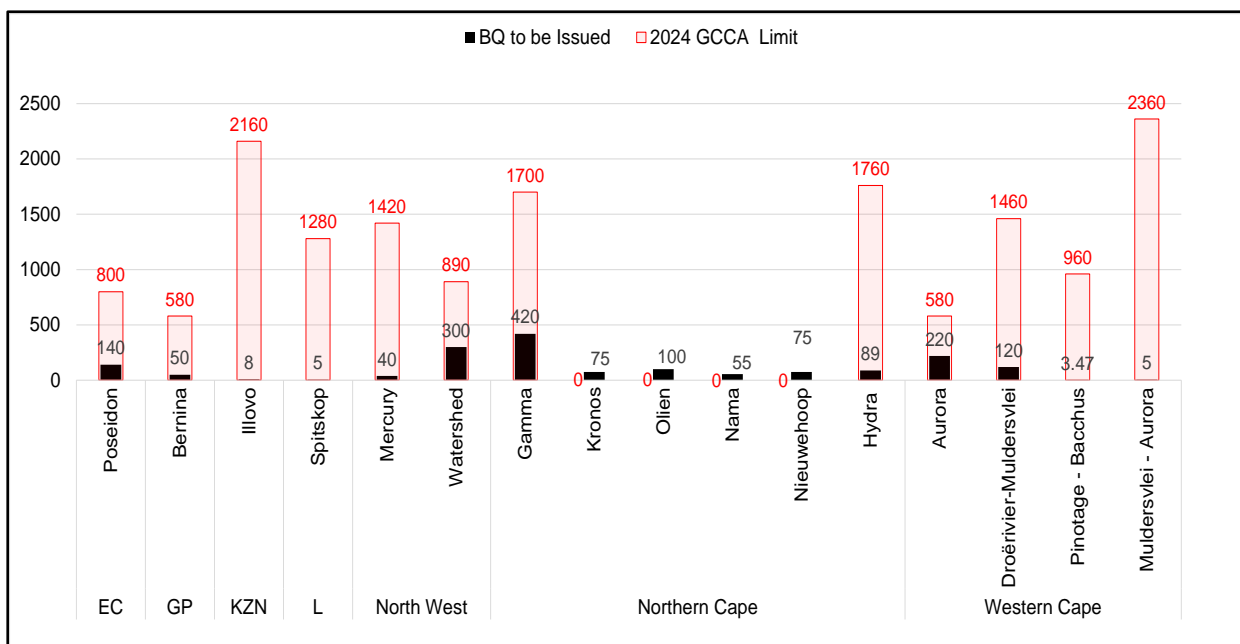

Figure 21: Graphic diagram showing BQ to be issued

Conclusion

The publication of the GCCA-2024 is to inform stakeholders of the potential capacity available on the Eskom transmission network to facilitate connection of generation projects for REIPPPP BW6. This report presents the results of available generation connection capacity of all the transmission substations in all the supply areas in all the provinces of South Africa.

Development Team

This document was developed by the following team members.

I. Mokwena	Engineer – Strategic Grid Planning
S. G. Satimburwa	Senior Engineer – Strategic Grid Planning
B. Dlamini	Senior Engineer – Strategic Grid Planning
S. Ferreira	Senior technologist – Strategic Grid planning
D. Matshidza	Chief Technologist – Strategic Grid Planning
R. Marais	Senior Manager – Strategic Grid Planning

Annexure A: Western Cape Supply Area IPPs

Table 12: Western Cape Supply Area IPPs

NAME	TECHNOLOGY	CAPACITY (MW)	PROGRAMME	MTS[Zone]	STATUS
Darling	Wind	5	Eskom	Aurora	Operational
Slim Sun	PV	5	BW1	Aurora	Operational
Aurora	PV	10.35	BW2	Aurora	Operational
Electra Capital	PV	75	BW3	Aurora	Operational
Hopefield	Wind	65.4	BW1	Aurora	Operational
Karpowership	LNG	320	RMIPP	Aurora	DRA
West Coast 1	Wind	90.8	BW2	Aurora	Operational
Excelsior	Wind	32	BW4	Bacchus	Operational
Dassiesklip	Wind	26.2	BW1	Bacchus	Operational
Touwsrivier	PV	36	BW1	Bacchus	Operational
Nobelsfontein	Wind	73	BW1	Droerivier	Operational
Beaufort West	Wind	140	BW5	Droerivier B	DRA
Trakas	Wind	140	BW5	Droerivier B	DRA
Grootfontein PV 1	PV	75	BW5	Kappa	DRA
Grootfontein PV 2	PV	75	BW5	Kappa	DRA
Grootfontein PV 3	PV	75	BW5	Kappa	DRA
Perdekraal East	Wind	108	BW4	Kappa	Operational
Oya Energy	Hybrid	128	RMIPP	Kappa	DRA
Roggeveld	Wind	140	BW4	Komsberg	Operational
Brandvalley	Wind	140	BW5	Komsberg	DRA
Karusa	Wind	140	BW4	Komsberg	Operational
Rietkloof	Wind	140	BW5	Komsberg	DRA
Soetwater	Wind	139	BW4	Komsberg	Operational
Rietrug	Wind	140	BW5	Koring	DRA
Sutherland	Wind	140	BW5	Koring	DRA
Gouda	Wind	135.2	BW2	Muldersvlei	Operational

Annexure B: Great Northern Cape Area IPPs

Table 13: Great Northern Cape Area IPPs

NAME	TECHNOLOGY	CAPACITY (MW)	PROGRAMME	MTS[Zone]	STATUS
Aggeneys	PV	40	BW4	Aggeneis	Operational
Aries Solar	PV	9.7	BW1	Aries	Operational
Droogfontein 2	PV	75	BW4	Boundary	Operational
Droogfontein	PV	50	BW1	Boundary	Operational
Graspan	PV	75	BW5	Boundary	DRA
Boshoff	PV	60	BW2	Boundary	Operational
Pulida	PV	75	BW3	Boundary	Operational
Adams Solar	PV	82.5	BW3	Ferrum	Operational
Kathu	PV	75	BW1	Ferrum	Operational
Kathu	CSP	100	BW3	Ferrum	Operational
Sishen	PV	74	BW2	Ferrum	Operational
Bokpoort	CSP	50	BW2	Garona	Operational
Project DOA	PV	150	RMIPP	Garona	DRA
Kangnas	Wind	137	BW4	Groeipunt	Operational
Dwarsrug	Wind	124	BW5	Helios	DRA
Khobab	Wind	138	BW3	Helios	Operational
Loeriesfontein 2	Wind	138	BW3	Helios	Operational
Loeriesfontein	PV	75	BW4	Helios	Execution
Sere	Wind	100	Eskom	Juno	Operational
Vredendal	PV	8.8	BW2	Juno	Operational
Copperton	Wind	102	BW4	Kronos	Operational
Garob Wind Farm	Wind	136	BW4	Kronos	Operational
Greefspan	PV	10	BW1	Kronos	Operational
Greefspan 2	PV	55	BW4	Kronos	Operational
Mulilo Prieska	PV	75	BW3	Kronos	Operational
Mulilo Renewable	PV	20	BW1	Kronos	Operational
Mulilo Sonnedix	PV	75	BW3	Kronos	Operational
Waterloo	PV	75	BW4	Mookodi	Operational
Gemsbok	Hybrid	197	RMIPP	Nieuwehoop	DRA
Scatec Kenhardt1	PV	50	RMIPP	Nieuwehoop	DRA
Scatec Kenhardt2	PV	50	RMIPP	Nieuwehoop	DRA
Scatec Kenhardt 3	PV	50	RMIPP	Nieuwehoop	DRA
Herbert	PV	19.9	BW1	Olien	Operational
Jasper	PV	75	BW2	Olien	Operational
Lesedi	PV	64	BW1	Olien	Operational
Redstone	CSP	100	BW3	Olien	Execution

NAME	TECHNOLOGY	CAPACITY (MW)	PROGRAMME	MTS[Zone]	STATUS
KaXu	CSP	100	BW1	Paulputs	Operational
Konkoonsies II	PV	75	BW4	Paulputs	Operational
Konkoonsies	PV	9.7	BW1	Paulputs	Operational
Xina	CSP	100	BW3	Paulputs	Operational
Avondale	PV	75	RMIPP	Upington	DRA
Dyason's Klip 1	PV	75	BW4	Upington	Operational
Dyason's Klip 2	PV	75	BW4	Upington	Operational
Ilanga CSP 1	CSP	100	BW3	Upington	Operational
Khi Solar One	CSP	50	BW1	Upington	Operational
Neusberg	Small Hydro	10	BW3	Upington	Operational
Sirius Solar	PV	75	BW4	Upington	Operational
Upington	PV	8.9	BW2	Upington	Operational

Annexure C: Hydra Cluster Supply Area IPPs

Table 14: Hydra Cluster Supply Area IPPs

NAME	TECHNOLOGY	CAPACITY (MW)	PROGRAMME	MTS[Zone]	STATUS
De Aar Solar Power	PV	50	BW1	Hydra	Operational
Kalkbult	PV	72.5	BW1	Hydra	Operational
Linde	PV	36.8	BW2	Hydra	Operational
De Aar	PV	10	BW1	Hydra	Operational
Noupoort Mainstream	Wind	79	BW3	Hydra	Operational
Solar Capital De Aar	PV	75	BW1	Hydra	Operational
Solar Capital De Aar 3	PV	75	BW1	Hydra	Operational
Mulilo De Aar Total	Hybrid	75	RMIPP	Hydra [Trfr 4]	DRA
Du Plessis Da	PV	75	BW5	Hydra [Trfr 4]	DRA
Longyuan Mulilo North	Wind	139	BW3	Hydra [Trfr 4]	Operational
Longyuan Mulilo	Wind	96	BW3	Hydra [Trfr 4]	Operational
Coleskop	Wind	140	BW5	Hydra D	DRA
Phezukomoya	Wind	140	BW5	Hydra D	DRA
San Kraal	Wind	140	BW5	Hydra D	DRA
Dreunberg	PV	75	BW2	Ruigtevallei	Operational

Annexure D: Eastern Cape Supply Area IPPs

Table 15: Eastern Cape Supply Area IPPs

NAME	TECHNOLOGY	CAPACITY (MW)	PROGRAMME	MTS[Zone]	STATUS
Mulilo Coega	LNG	197	RMIPP	Dedisa	DRA
Karpowership	LNG	450	RMIPP	Dedisa	DRA
Dorper	Wind	97	BW1	Delphi	Operational
Dassiesridge	Wind	80	RMIPP	Grassridge	DRA
Grassridge	Wind	59.8	BW2	Grassridge	Operational
Jeffrey's Bay	Wind	138	BW1	Grassridge	Operational
Kouga Wind	Wind	80	BW1	Grassridge	Operational
Metrowind	Wind	27	BW1	Grassridge	Operational
Oyster Bay	Wind	140	BW4	Grassridge	Operational
Red Cap	Wind	110	BW3	Grassridge	Operational
Tsitsikamma	Wind	95	BW2	Grassridge	Operational
Wolf Wind Farm	Wind	80	BW5	Grassridge	DRA
Wesley-Ciskei	Wind	33	BW4	Pembroke	Execution
Chaba	Wind	20.6	BW2	Pembroke	Operational
Amakhala Emoyeni	Wind	134.4	BW2	Poseidon	Operational
Cookhouse Wind Farm	Wind	135	BW1	Poseidon	Operational
Golden Valley	Wind	120	BW4	Poseidon	Operational
Nxuba Wind Farm	Wind	140	BW4	Poseidon	Operational
Waainek	Wind	23.4	BW2	Poseidon	Operational
Nojoli Wind Farm	Wind	87	BW3	Poseidon	Operational

Annexure E: Eastern Cape Supply Area IPPs

Table 16: Free State Supply Area IPPs

NAME	TECHNOLOGY	CAPACITY (MW)	PROGRAMME	MTS[ZONE]	STATUS
Braklaagte	PV	75	BW5	Artemis	DRA
Kentani	PV	75	BW5	Artemis	DRA
Klipfontein 2	PV	75	BW5	Artemis	DRA
Klipfontein	PV	75	BW5	Artemis	DRA
Leliehoek	PV	75	BW5	Artemis	DRA
Sonoblomo	PV	75	BW5	Artemis	DRA
Sannaspos	PV	75	BW5	Harvard	DRA
Letsatsi	PV	64	BW1	Harvard	Operational
Grootpoort	PV	75	BW5	Leander	DRA
Kruisvallei	Small Hydro	4.7	BW4	Tugela	Operational
Stortemelk	Small Hydro	4.3	BW3	Tugela	Operational

Annexure F: North West Supply Area IPPs

Table 17: Northwest Supply Area IPPs

NAME	TECHNOLOGY	CAPACITY (MW)	PROGRAMME	MTS[Zone]	STATUS
RustMo1	PV	6.8	BW1	Bighorn	Operational
De Wildt	PV	50	BW4	Lomond*	Operational
Bokamoso	PV	68	BW4	Mercury	Operational
Zeerust	PV	75	BW4	Watershed	Operational

Annexure G: Limpopo Supply Area IPPs

Table 18: Limpopo Supply Area IPPs

NAME	TECHNOLOGY	CAPACITY (MW)	PROGRAMME	MTS[Zone]	STATUS
Tom Burke	PV	60	BW3	Matimba	Operational
Soutpan	PV	28	BW1	Tabor	Operational
Witkop	PV	30	BW1	Witkop	Operational

Annexure H: KZN Supply Area IPPs

Table 19: KZN Supply Area IPPs

NAME	TECHNOLOGY	CAPACITY (MW)	PROGRAMME	MTS[Zone]	STATUS
Karpowership	LNG	450	RMIPP	Impala	DRA
Waaihoek	Wind	140	BW5	Bloedrivier	DRA